

# Mincost Flow

## Problem Definition:

$$\begin{array}{ll} \min & \sum_e c(e)f(e) \\ \text{s.t.} & \forall e \in E: 0 \leq f(e) \leq u(e) \\ & \forall v \in V: f(v) = b(v) \end{array}$$

## Problem Definition:

$$\begin{aligned} \min \quad & \sum_e c(e)f(e) \\ \text{s.t.} \quad & \forall e \in E: 0 \leq f(e) \leq u(e) \\ & \forall v \in V: f(v) = b(v) \end{aligned}$$

- ▶  $G = (V, E)$  is a **directed graph**.

## Problem Definition:

$$\begin{aligned} \min \quad & \sum_e c(e)f(e) \\ \text{s.t.} \quad & \forall e \in E: 0 \leq f(e) \leq u(e) \\ & \forall v \in V: f(v) = b(v) \end{aligned}$$

- ▶  $G = (V, E)$  is a **directed graph**.
- ▶  $u : E \rightarrow \mathbb{R}_0^+ \cup \{\infty\}$  is the **capacity function**.

## Problem Definition:

$$\begin{aligned} \min \quad & \sum_e c(e)f(e) \\ \text{s.t.} \quad & \forall e \in E: 0 \leq f(e) \leq u(e) \\ & \forall v \in V: f(v) = b(v) \end{aligned}$$

- ▶  $G = (V, E)$  is a **directed graph**.
- ▶  $u : E \rightarrow \mathbb{R}_0^+ \cup \{\infty\}$  is the **capacity function**.
- ▶  $c : E \rightarrow \mathbb{R}$  is the **cost function**  
(note that  $c(e)$  may be negative).

## Problem Definition:

$$\begin{aligned} \min \quad & \sum_e c(e)f(e) \\ \text{s.t.} \quad & \forall e \in E: 0 \leq f(e) \leq u(e) \\ & \forall v \in V: f(v) = b(v) \end{aligned}$$

- ▶  $G = (V, E)$  is a **directed graph**.
- ▶  $u : E \rightarrow \mathbb{R}_0^+ \cup \{\infty\}$  is the **capacity function**.
- ▶  $c : E \rightarrow \mathbb{R}$  is the **cost function**  
(note that  $c(e)$  may be negative).
- ▶  $b : V \rightarrow \mathbb{R}, \sum_{v \in V} b(v) = 0$  is a **demand function**.

# Solve Maxflow Using Mincost Flow

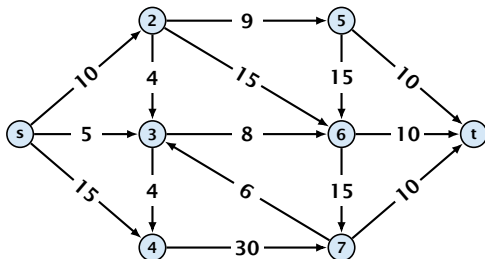

# Solve Maxflow Using Mincost Flow

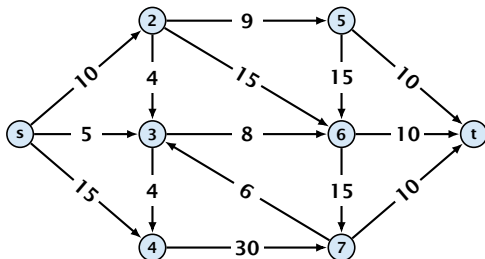

- ▶ Given a flow network for a standard maxflow problem.

# Solve Maxflow Using Mincost Flow

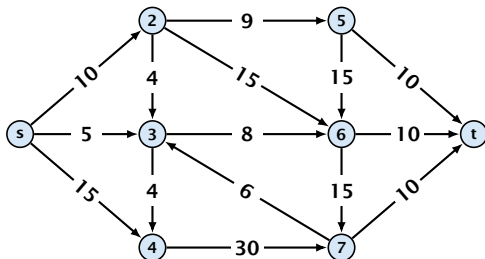

- ▶ Given a flow network for a standard maxflow problem.
- ▶ Set  $b(v) = 0$  for every node. Keep the capacity function  $u$  for all edges. Set the cost  $c(e)$  for every edge to 0.



# Solve Maxflow Using Mincost Flow

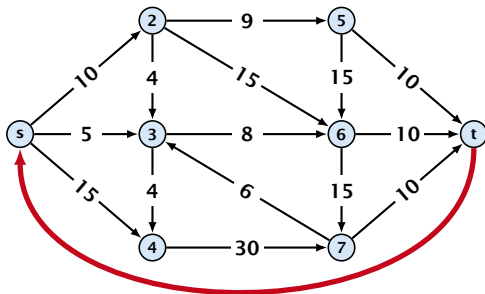

- ▶ Given a flow network for a standard maxflow problem.
- ▶ Set  $b(v) = 0$  for every node. Keep the capacity function  $u$  for all edges. Set the cost  $c(e)$  for every edge to 0.
- ▶ Add an edge from  $t$  to  $s$  with infinite capacity and cost  $-1$ .

# Solve Maxflow Using Mincost Flow

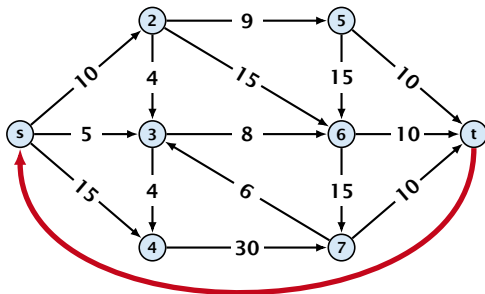

- ▶ Given a flow network for a standard maxflow problem.
- ▶ Set  $b(v) = 0$  for every node. Keep the capacity function  $u$  for all edges. Set the cost  $c(e)$  for every edge to 0.
- ▶ Add an edge from  $t$  to  $s$  with infinite capacity and cost  $-1$ .
- ▶ Then,  $\text{val}(f^*) = -\text{cost}(f_{\min})$ , where  $f^*$  is a maxflow, and  $f_{\min}$  is a mincost-flow.

# Solve Maxflow Using Mincost Flow

## Solve decision version of maxflow:

- ▶ Given a flow network for a standard maxflow problem, and a value  $k$ .

# Solve Maxflow Using Mincost Flow

## Solve decision version of maxflow:

- ▶ Given a flow network for a standard maxflow problem, and a value  $k$ .
- ▶ Set  $b(v) = 0$  for every node apart from  $s$  or  $t$ . Set  $b(s) = -k$  and  $b(t) = k$ .

# Solve Maxflow Using Mincost Flow

## Solve decision version of maxflow:

- ▶ Given a flow network for a standard maxflow problem, and a value  $k$ .
- ▶ Set  $b(v) = 0$  for every node apart from  $s$  or  $t$ . Set  $b(s) = -k$  and  $b(t) = k$ .
- ▶ Set edge-costs to zero, and keep the capacities.

# Solve Maxflow Using Mincost Flow

## Solve decision version of maxflow:

- ▶ Given a flow network for a standard maxflow problem, and a value  $k$ .
- ▶ Set  $b(v) = 0$  for every node apart from  $s$  or  $t$ . Set  $b(s) = -k$  and  $b(t) = k$ .
- ▶ Set edge-costs to zero, and keep the capacities.
- ▶ There exists a maxflow of value at least  $k$  if and only if the mincost-flow problem is feasible.

# Generalization

**Our model:**

$$\begin{aligned} \min \quad & \sum_e c(e) f(e) \\ \text{s.t.} \quad & \forall e \in E: 0 \leq f(e) \leq u(e) \\ & \forall v \in V: f(v) = b(v) \end{aligned}$$

where  $b : V \rightarrow \mathbb{R}$ ,  $\sum_v b(v) = 0$ ;  $u : E \rightarrow \mathbb{R}_0^+ \cup \{\infty\}$ ;  $c : E \rightarrow \mathbb{R}$ ;

# Generalization

**Our model:**

$$\begin{aligned} \min \quad & \sum_e c(e)f(e) \\ \text{s.t.} \quad & \forall e \in E: 0 \leq f(e) \leq u(e) \\ & \forall v \in V: f(v) = b(v) \end{aligned}$$

where  $b: V \rightarrow \mathbb{R}$ ,  $\sum_v b(v) = 0$ ;  $u: E \rightarrow \mathbb{R}_0^+ \cup \{\infty\}$ ;  $c: E \rightarrow \mathbb{R}$ ;

**A more general model?**

$$\begin{aligned} \min \quad & \sum_e c(e)f(e) \\ \text{s.t.} \quad & \forall e \in E: \ell(e) \leq f(e) \leq u(e) \\ & \forall v \in V: a(v) \leq f(v) \leq b(v) \end{aligned}$$

where  $a: V \rightarrow \mathbb{R}$ ,  $b: V \rightarrow \mathbb{R}$ ;  $\ell: E \rightarrow \mathbb{R} \cup \{-\infty\}$ ,  $u: E \rightarrow \mathbb{R} \cup \{\infty\}$   
 $c: E \rightarrow \mathbb{R}$ ;



## Differences

- ▶ Flow along an edge  $e$  may have non-zero lower bound  $\ell(e)$ .
- ▶ Flow along  $e$  may have negative upper bound  $u(e)$ .
- ▶ The demand at a node  $v$  may have lower bound  $a(v)$  and upper bound  $b(v)$  instead of just lower bound = upper bound =  $b(v)$ .

## Reduction I

$$\begin{array}{ll} \min & \sum_e c(e)f(e) \\ \text{s.t.} & \forall e \in E: \ell(e) \leq f(e) \leq u(e) \\ & \forall v \in V: a(v) \leq f(v) \leq b(v) \end{array}$$

## Reduction I

$$\begin{aligned} \min \quad & \sum_e c(e)f(e) \\ \text{s.t.} \quad & \forall e \in E: \ell(e) \leq f(e) \leq u(e) \\ & \forall v \in V: a(v) \leq f(v) \leq b(v) \end{aligned}$$

**We can assume that  $a(v) = b(v)$ :**

## Reduction I

$$\begin{aligned} \min \quad & \sum_e c(e) f(e) \\ \text{s.t.} \quad & \forall e \in E: \ell(e) \leq f(e) \leq u(e) \\ & \forall v \in V: a(v) \leq f(v) \leq b(v) \end{aligned}$$

We can assume that  $a(v) = b(v)$ :

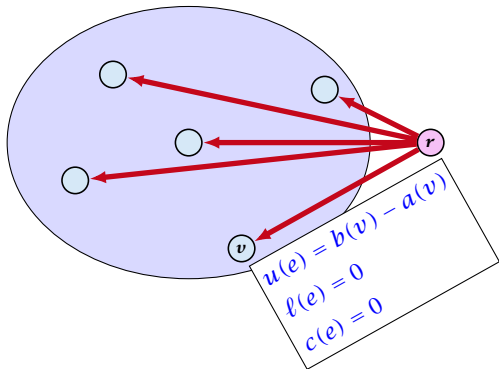

## Reduction I

$$\begin{aligned} \min \quad & \sum_e c(e) f(e) \\ \text{s.t.} \quad & \forall e \in E: \ell(e) \leq f(e) \leq u(e) \\ & \forall v \in V: a(v) \leq f(v) \leq b(v) \end{aligned}$$

We can assume that  $a(v) = b(v)$ :

Add new node  $r$ .

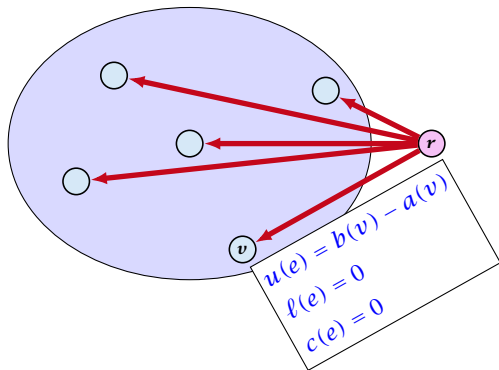

## Reduction I

$$\begin{aligned} \min \quad & \sum_e c(e)f(e) \\ \text{s.t.} \quad & \forall e \in E: \ell(e) \leq f(e) \leq u(e) \\ & \forall v \in V: a(v) \leq f(v) \leq b(v) \end{aligned}$$

We can assume that  $a(v) = b(v)$ :

Add new node  $r$ .

Add edge  $(r, v)$  for all  $v \in V$ .

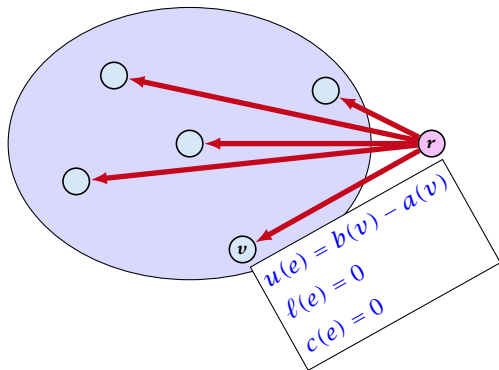

## Reduction I

$$\begin{aligned} \min \quad & \sum_e c(e)f(e) \\ \text{s.t.} \quad & \forall e \in E: \ell(e) \leq f(e) \leq u(e) \\ & \forall v \in V: a(v) \leq f(v) \leq b(v) \end{aligned}$$

We can assume that  $a(v) = b(v)$ :

Add new node  $r$ .

Add edge  $(r, v)$  for all  $v \in V$ .

Set  $\ell(e) = c(e) = 0$  for these edges.

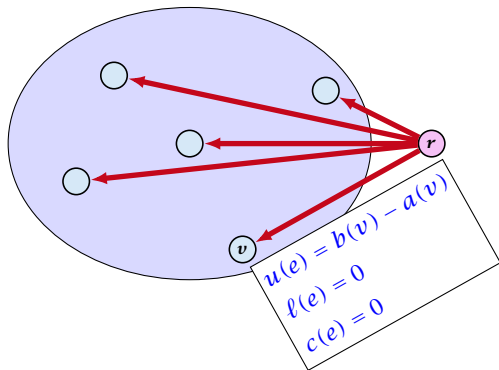

## Reduction I

$$\begin{aligned} \min \quad & \sum_e c(e)f(e) \\ \text{s.t.} \quad & \forall e \in E: \ell(e) \leq f(e) \leq u(e) \\ & \forall v \in V: a(v) \leq f(v) \leq b(v) \end{aligned}$$

We can assume that  $a(v) = b(v)$ :

Add new node  $r$ .

Add edge  $(r, v)$  for all  $v \in V$ .

Set  $\ell(e) = c(e) = 0$  for these edges.

Set  $u(e) = b(v) - a(v)$  for edge  $(r, v)$ .

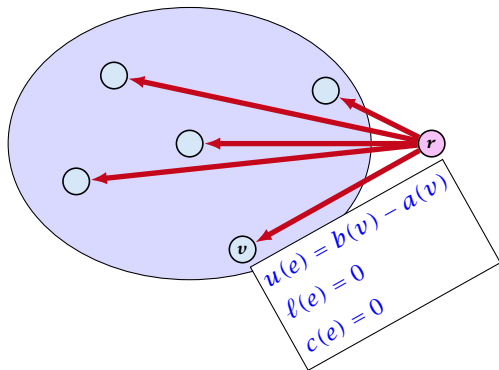



## Reduction I

$$\begin{aligned} \min \quad & \sum_e c(e)f(e) \\ \text{s.t.} \quad & \forall e \in E: \ell(e) \leq f(e) \leq u(e) \\ & \forall v \in V: a(v) \leq f(v) \leq b(v) \end{aligned}$$

We can assume that  $a(v) = b(v)$ :

Add new node  $r$ .

Add edge  $(r, v)$  for all  $v \in V$ .

Set  $\ell(e) = c(e) = 0$  for these edges.

Set  $u(e) = b(v) - a(v)$  for edge  $(r, v)$ .

Set  $a(v) = b(v)$  for all  $v \in V$ .

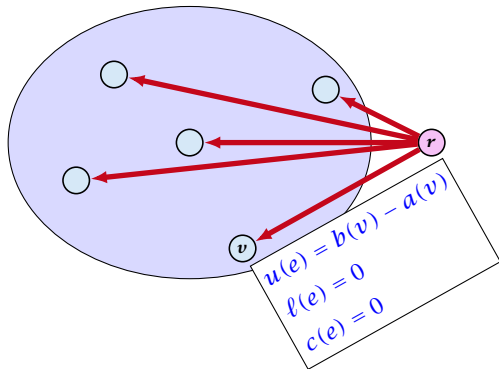

## Reduction I

$$\begin{aligned} \min \quad & \sum_e c(e)f(e) \\ \text{s.t.} \quad & \forall e \in E: \ell(e) \leq f(e) \leq u(e) \\ & \forall v \in V: a(v) \leq f(v) \leq b(v) \end{aligned}$$

We can assume that  $a(v) = b(v)$ :

Add new node  $r$ .

Add edge  $(r, v)$  for all  $v \in V$ .

Set  $\ell(e) = c(e) = 0$  for these edges.

Set  $u(e) = b(v) - a(v)$  for edge  $(r, v)$ .

Set  $a(v) = b(v)$  for all  $v \in V$ .

Set  $b(r) = -\sum_{v \in V} b(v)$ .

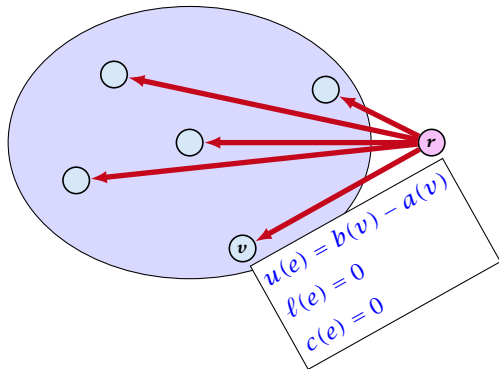

## Reduction I

$$\begin{aligned} \min \quad & \sum_e c(e)f(e) \\ \text{s.t.} \quad & \forall e \in E: \ell(e) \leq f(e) \leq u(e) \\ & \forall v \in V: a(v) \leq f(v) \leq b(v) \end{aligned}$$

We can assume that  $a(v) = b(v)$ :

Add new node  $r$ .

Add edge  $(r, v)$  for all  $v \in V$ .

Set  $\ell(e) = c(e) = 0$  for these edges.

Set  $u(e) = b(v) - a(v)$  for edge  $(r, v)$ .

Set  $a(v) = b(v)$  for all  $v \in V$ .

Set  $b(r) = -\sum_{v \in V} b(v)$ .

$-\sum_v b(v)$  is negative; hence  $r$  is only sending flow.

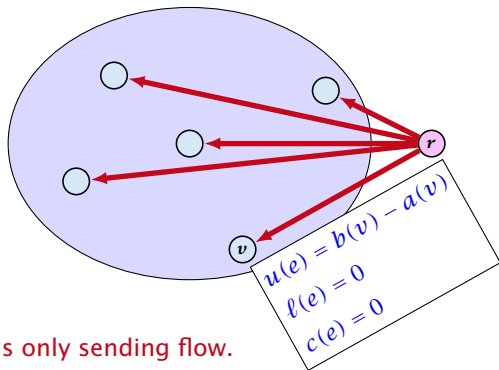

# Reduction II

$$\begin{aligned} \min \quad & \sum_e c(e)f(e) \\ \text{s.t.} \quad & \forall e \in E: \ell(e) \leq f(e) \leq u(e) \\ & \forall v \in V: f(v) = b(v) \end{aligned}$$

We can assume that either  $\ell(e) \neq -\infty$  or  $u(e) \neq \infty$ :

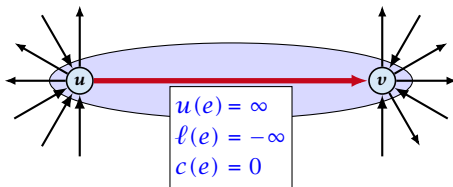

## Reduction II

$$\begin{aligned} \min \quad & \sum_e c(e)f(e) \\ \text{s.t.} \quad & \forall e \in E: \ell(e) \leq f(e) \leq u(e) \\ & \forall v \in V: f(v) = b(v) \end{aligned}$$

We can assume that either  $\ell(e) \neq -\infty$  or  $u(e) \neq \infty$ :

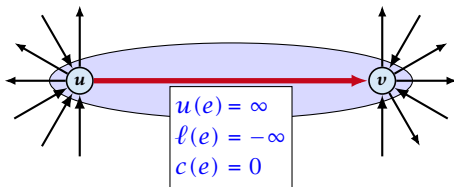

If  $c(e) = 0$  we can contract the edge/identify nodes  $u$  and  $v$ .

## Reduction II

$$\begin{aligned} \min \quad & \sum_e c(e)f(e) \\ \text{s.t.} \quad & \forall e \in E: \ell(e) \leq f(e) \leq u(e) \\ & \forall v \in V: f(v) = b(v) \end{aligned}$$

We can assume that either  $\ell(e) \neq -\infty$  or  $u(e) \neq \infty$ :

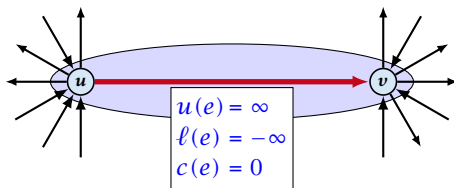

If  $c(e) = 0$  we can contract the edge/identify nodes  $u$  and  $v$ .

If  $c(e) \neq 0$  we can transform the graph so that  $c(e) = 0$ .

## Reduction II

We can transform any network so that a particular edge has cost  $c(e) = 0$ :

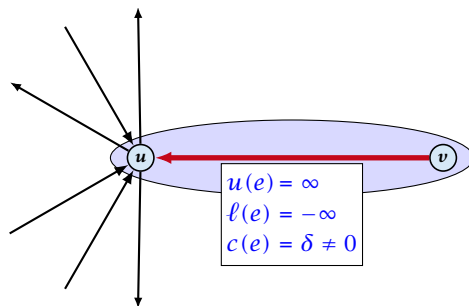

## Reduction II

We can transform any network so that a particular edge has cost  $c(e) = 0$ :

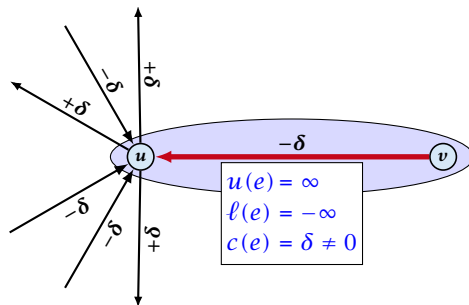



## Reduction II

We can transform any network so that a particular edge has cost  $c(e) = 0$ :

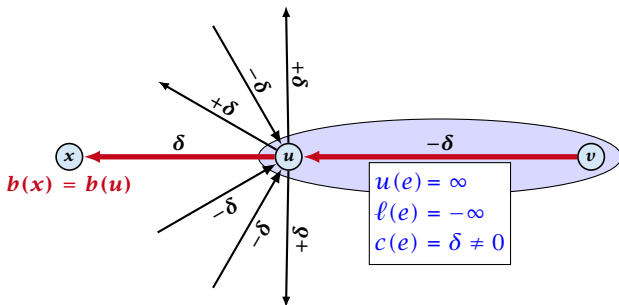

Additionally we set  $b(u) = 0$ .

## Reduction III

$$\begin{aligned} \min \quad & \sum_e c(e)f(e) \\ \text{s.t.} \quad & \forall e \in E: \ell(e) \leq f(e) \leq u(e) \\ & \forall v \in V: f(v) = b(v) \end{aligned}$$

We can assume that  $\ell(e) \neq -\infty$ :

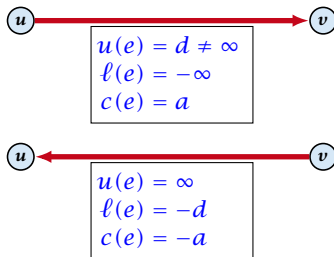

Replace the edge by an edge in opposite direction.

## Reduction IV

$$\begin{aligned} \min \quad & \sum_e c(e)f(e) \\ \text{s.t.} \quad & \forall e \in E: \ell(e) \leq f(e) \leq u(e) \\ & \forall v \in V: f(v) = b(v) \end{aligned}$$

We can assume that  $\ell(e) = 0$ :

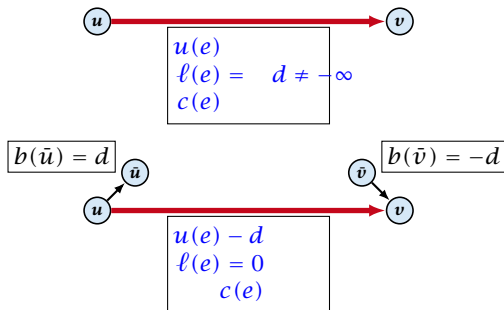

The added edges have infinite capacity and cost  $c(e)/2$ .

## Caterer Problem

- ▶ She needs to supply  $r_i$  napkins on  $N$  successive days.

# Applications

## Caterer Problem

- ▶ She needs to supply  $r_i$  napkins on  $N$  successive days.
- ▶ She can buy new napkins at  $p$  cents each.

## Caterer Problem

- ▶ She needs to supply  $r_i$  napkins on  $N$  successive days.
- ▶ She can buy new napkins at  $p$  cents each.
- ▶ She can launder them at a fast laundry that takes  $m$  days and cost  $f$  cents a napkin.

## Caterer Problem

- ▶ She needs to supply  $r_i$  napkins on  $N$  successive days.
- ▶ She can buy new napkins at  $p$  cents each.
- ▶ She can launder them at a fast laundry that takes  $m$  days and cost  $f$  cents a napkin.
- ▶ She can use a slow laundry that takes  $k > m$  days and costs  $s$  cents each.

## Caterer Problem

- ▶ She needs to supply  $r_i$  napkins on  $N$  successive days.
- ▶ She can buy new napkins at  $p$  cents each.
- ▶ She can launder them at a fast laundry that takes  $m$  days and cost  $f$  cents a napkin.
- ▶ She can use a slow laundry that takes  $k > m$  days and costs  $s$  cents each.
- ▶ At the end of each day she should determine how many to send to each laundry and how many to buy in order to fulfill demand.



## Caterer Problem

- ▶ She needs to supply  $r_i$  napkins on  $N$  successive days.
- ▶ She can buy new napkins at  $p$  cents each.
- ▶ She can launder them at a fast laundry that takes  $m$  days and cost  $f$  cents a napkin.
- ▶ She can use a slow laundry that takes  $k > m$  days and costs  $s$  cents each.
- ▶ At the end of each day she should determine how many to send to each laundry and how many to buy in order to fulfill demand.
- ▶ Minimize cost.



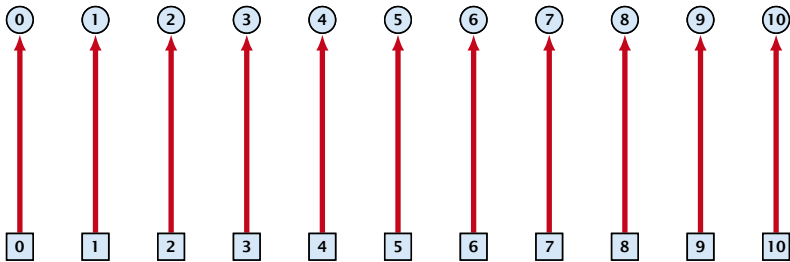

day edges:

upper bound:  $u(e_i) = \infty$ ;  
lower bound:  $\ell(e_i) = r_i$ ;  
cost:  $c(e) = 0$

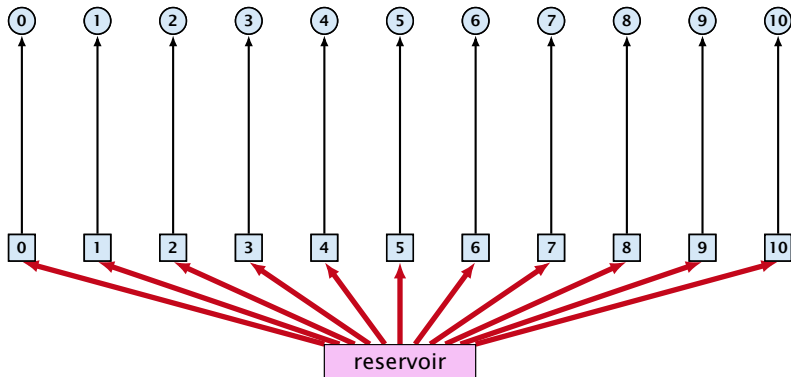

buy edges:

upper bound:  $u(e_i) = \infty$ ;  
lower bound:  $\ell(e_i) = 0$ ;  
cost:  $c(e) = p$

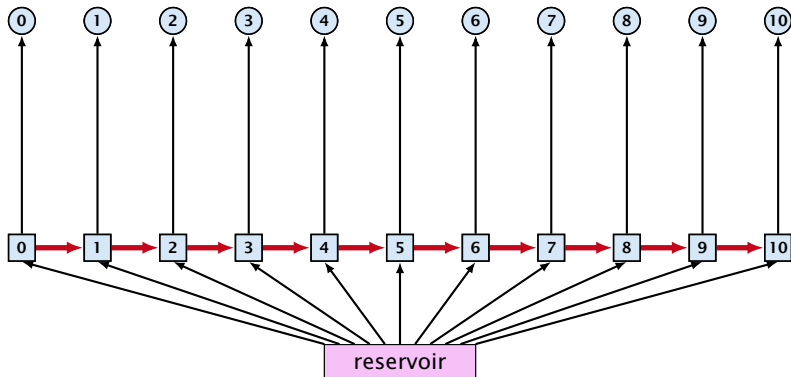

forward edges:

upper bound:  $u(e_i) = \infty$ ;  
lower bound:  $\ell(e_i) = 0$ ;  
cost:  $c(e) = 0$

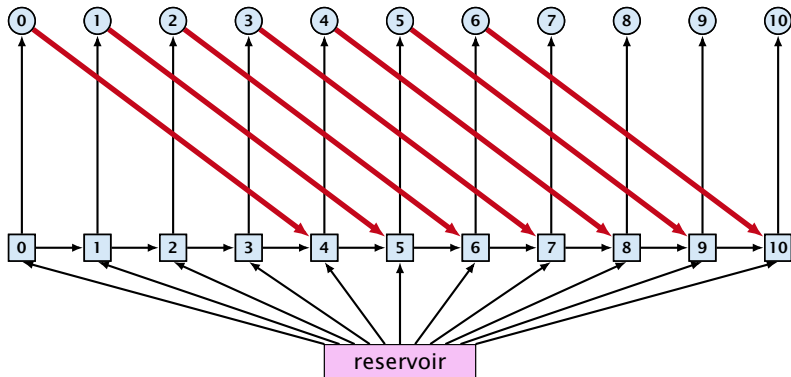

slow edges:

upper bound:  $u(e_i) = \infty$ ;  
 lower bound:  $\ell(e_i) = 0$ ;  
 cost:  $c(e) = s$

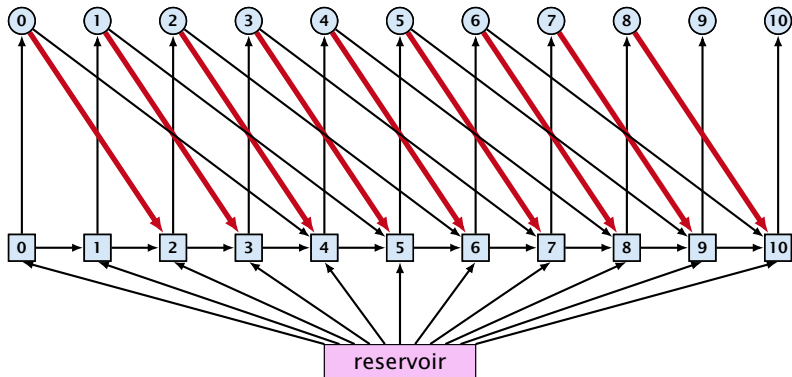

fast edges:

upper bound:  $u(e_i) = \infty$ ;  
 lower bound:  $\ell(e_i) = 0$ ;  
 cost:  $c(e) = f$

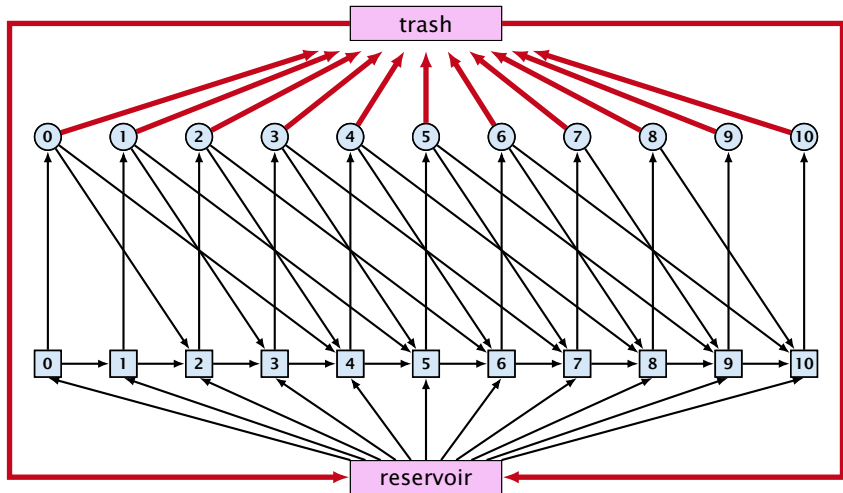

trash edges:

upper bound:  $u(e_i) = \infty$ ;  
 lower bound:  $\ell(e_i) = 0$ ;  
 cost:  $c(e) = 0$



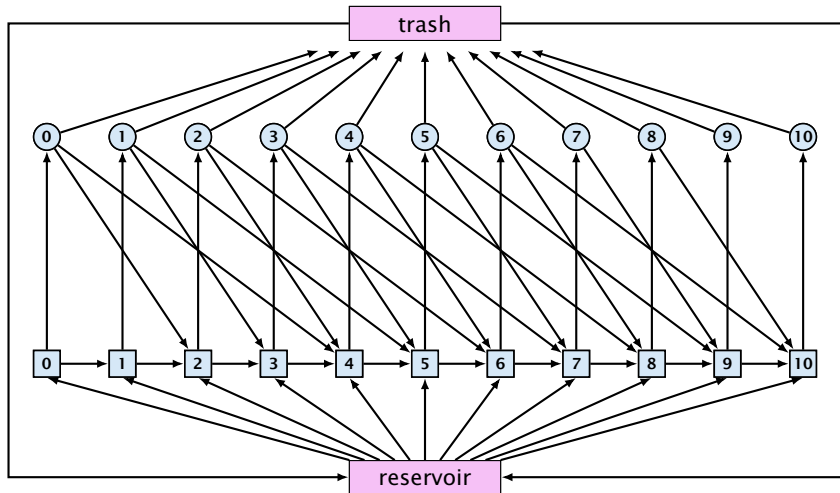

# Residual Graph

## Version A:

The residual graph  $G'$  for a mincost flow is just a copy of the graph  $G$ .

If we send  $f(e)$  along an edge, the corresponding edge  $e'$  in the residual graph has its lower and upper bound changed to  $l(e') = l(e) - f(e)$  and  $u(e') = u(e) - f(e)$ .

# Residual Graph

## Version A:

The residual graph  $G'$  for a mincost flow is just a copy of the graph  $G$ .

If we send  $f(e)$  along an edge, the corresponding edge  $e'$  in the residual graph has its lower and upper bound changed to  $l(e') = l(e) - f(e)$  and  $u(e') = u(e) - f(e)$ .

## Version B:

The residual graph for a mincost flow is exactly defined as the residual graph for standard flows, with the only exception that one needs to define a cost for the residual edge.

For a flow of  $z$  from  $u$  to  $v$  the residual edge  $(v, u)$  has capacity  $z$  and a cost of  $-c((u, v))$ .

# 14 Mincost Flow

A **circulation** in a graph  $G = (V, E)$  is a function  $f : E \rightarrow \mathbb{R}^+$  that has an excess flow  $f(v) = 0$  for every node  $v \in V$ .

# 14 Mincost Flow

A **circulation** in a graph  $G = (V, E)$  is a function  $f : E \rightarrow \mathbb{R}^+$  that has an excess flow  $f(v) = 0$  for every node  $v \in V$ .

A circulation is **feasible** if it fulfills capacity constraints, i.e.,  $f(e) \leq u(e)$  for every edge of  $G$ .

## Lemma 6

*A given flow is a mincost-flow if and only if the corresponding residual graph  $G_f$  does not have a feasible circulation of negative cost.*

## Lemma 6

*A given flow is a mincost-flow if and only if the corresponding residual graph  $G_f$  does not have a feasible circulation of negative cost.*

- ⇒ Suppose that  $g$  is a feasible circulation of negative cost in the residual graph.

## Lemma 6

*A given flow is a mincost-flow if and only if the corresponding residual graph  $G_f$  does not have a feasible circulation of negative cost.*

⇒ Suppose that  $g$  is a feasible circulation of negative cost in the residual graph.

Then  $f + g$  is a feasible flow with cost  $\text{cost}(f) + \text{cost}(g) < \text{cost}(f)$ . Hence,  $f$  is not minimum cost.



## Lemma 6

*A given flow is a mincost-flow if and only if the corresponding residual graph  $G_f$  does not have a feasible circulation of negative cost.*

⇒ Suppose that  $g$  is a feasible circulation of negative cost in the residual graph.

Then  $f + g$  is a feasible flow with cost  $\text{cost}(f) + \text{cost}(g) < \text{cost}(f)$ . Hence,  $f$  is not minimum cost.

⇐ Let  $f$  be a non-mincost flow, and let  $f^*$  be a min-cost flow. We need to show that the residual graph has a feasible circulation with negative cost.

## Lemma 6

*A given flow is a mincost-flow if and only if the corresponding residual graph  $G_f$  does not have a feasible circulation of negative cost.*

⇒ Suppose that  $g$  is a feasible circulation of negative cost in the residual graph.

Then  $f + g$  is a feasible flow with cost  $\text{cost}(f) + \text{cost}(g) < \text{cost}(f)$ . Hence,  $f$  is not minimum cost.

⇐ Let  $f$  be a non-mincost flow, and let  $f^*$  be a min-cost flow. We need to show that the residual graph has a feasible circulation with negative cost.

Clearly  $f^* - f$  is a circulation of negative cost. One can also easily see that it is feasible for the residual graph. (after sending  $-f$  in the residual graph (pushing all flow back) we arrive at the original graph; for this  $f^*$  is clearly feasible)

## 14 Mincost Flow

### Lemma 7

*A graph (without zero-capacity edges) has a feasible circulation of negative cost if and only if it has a negative cycle w.r.t. edge-weights  $c : E \rightarrow \mathbb{R}$ .*

## 14 Mincost Flow

### Lemma 7

*A graph (without zero-capacity edges) has a feasible circulation of negative cost if and only if it has a negative cycle w.r.t. edge-weights  $c : E \rightarrow \mathbb{R}$ .*

### Proof.

- ▶ Suppose that we have a negative cost circulation.

## 14 Mincost Flow

### Lemma 7

*A graph (without zero-capacity edges) has a feasible circulation of negative cost if and only if it has a negative cycle w.r.t. edge-weights  $c : E \rightarrow \mathbb{R}$ .*

### Proof.

- ▶ Suppose that we have a negative cost circulation.
- ▶ Find directed cycle only using edges that have non-zero flow.

## 14 Mincost Flow

### Lemma 7

*A graph (without zero-capacity edges) has a feasible circulation of negative cost if and only if it has a negative cycle w.r.t. edge-weights  $c : E \rightarrow \mathbb{R}$ .*

### Proof.

- ▶ Suppose that we have a negative cost circulation.
- ▶ Find directed cycle only using edges that have non-zero flow.
- ▶ If this cycle has negative cost you are done.

## 14 Mincost Flow

### Lemma 7

*A graph (without zero-capacity edges) has a feasible circulation of negative cost if and only if it has a negative cycle w.r.t. edge-weights  $c : E \rightarrow \mathbb{R}$ .*

### Proof.

- ▶ Suppose that we have a negative cost circulation.
- ▶ Find directed cycle only using edges that have non-zero flow.
- ▶ If this cycle has negative cost you are done.
- ▶ Otherwise send flow in opposite direction along the cycle until the bottleneck edge(s) does not carry any flow.

# 14 Mincost Flow

## Lemma 7

*A graph (without zero-capacity edges) has a feasible circulation of negative cost if and only if it has a negative cycle w.r.t. edge-weights  $c : E \rightarrow \mathbb{R}$ .*

### Proof.

- ▶ Suppose that we have a negative cost circulation.
- ▶ Find directed cycle only using edges that have non-zero flow.
- ▶ If this cycle has negative cost you are done.
- ▶ Otherwise send flow in opposite direction along the cycle until the bottleneck edge(s) does not carry any flow.
- ▶ You still have a circulation with negative cost.



## 14 Mincost Flow

### Lemma 7

*A graph (without zero-capacity edges) has a feasible circulation of negative cost if and only if it has a negative cycle w.r.t. edge-weights  $c : E \rightarrow \mathbb{R}$ .*

### Proof.

- ▶ Suppose that we have a negative cost circulation.
- ▶ Find directed cycle only using edges that have non-zero flow.
- ▶ If this cycle has negative cost you are done.
- ▶ Otherwise send flow in opposite direction along the cycle until the bottleneck edge(s) does not carry any flow.
- ▶ You still have a circulation with negative cost.
- ▶ Repeat.

## 14 Mincost Flow

### Algorithm 48 CycleCanceling( $G = (V, E), c, u, b$ )

- 1: establish a feasible flow  $f$  in  $G$
- 2: **while**  $G_f$  contains negative cycle **do**
- 3:     use Bellman-Ford to find a negative circuit  $Z$
- 4:      $\delta \leftarrow \min\{u_f(e) \mid e \in Z\}$
- 5:     augment  $\delta$  units along  $Z$  and update  $G_f$

## How do we find the initial feasible flow?

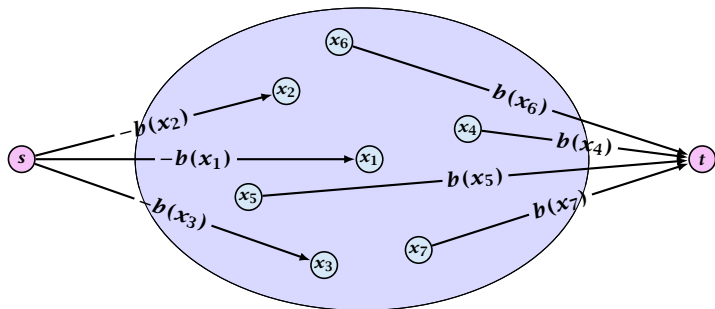

- ▶ Connect new node  $s$  to all nodes with negative  $b(v)$ -value.
- ▶ Connect nodes with positive  $b(v)$ -value to a new node  $t$ .
- ▶ There exist a feasible flow in the original graph iff in the resulting graph there exists an  $s$ - $t$  flow of value

$$\sum_{v:b(v)<0} (-b(v)) = \sum_{v:b(v)>0} b(v) .$$

# 14 Mincost Flow

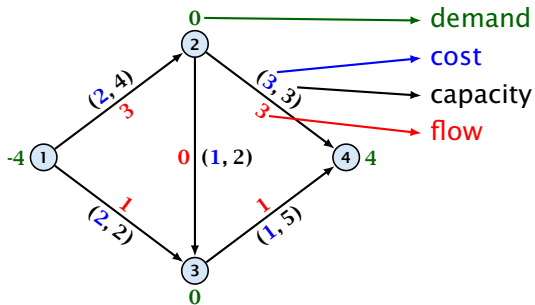

# 14 Mincost Flow

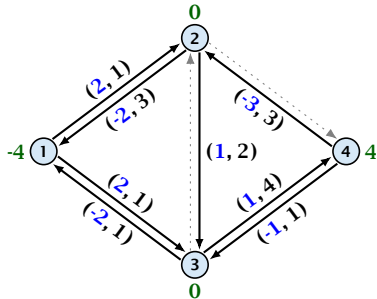

# 14 Mincost Flow

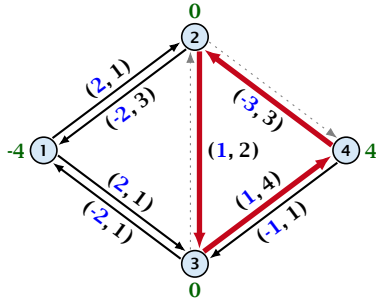

# 14 Mincost Flow

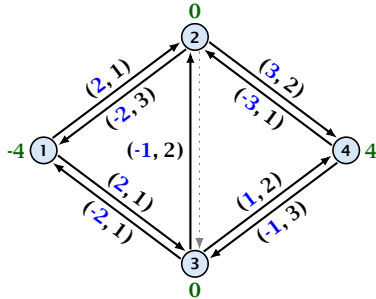

# 14 Mincost Flow

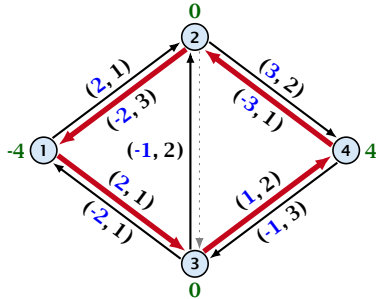



# 14 Mincost Flow

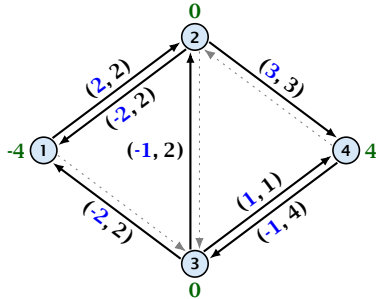

# 14 Mincost Flow

## Lemma 8

*The improving cycle algorithm runs in time  $\mathcal{O}(nm^2CU)$ , for integer capacities and costs, when for all edges  $e$ ,  $|c(e)| \leq C$  and  $|u(e)| \leq U$ .*

- ▶ Running time of Bellman-Ford is  $\mathcal{O}(mn)$ .
- ▶ Pushing flow along the cycle can be done in time  $\mathcal{O}(n)$ .
- ▶ Each iteration decreases the total cost by at least 1.
- ▶ The true optimum cost must lie in the interval  $[-mCU, \dots, +mCU]$ .

Note that this lemma is weak since it does not allow for edges with infinite capacity.

# 14 Mincost Flow

A **general mincost flow problem** is of the following form:

$$\begin{aligned} \min \quad & \sum_e c(e)f(e) \\ \text{s.t.} \quad & \forall e \in E: \ell(e) \leq f(e) \leq u(e) \\ & \forall v \in V: a(v) \leq f(v) \leq b(v) \end{aligned}$$

where  $a: V \rightarrow \mathbb{R}$ ,  $b: V \rightarrow \mathbb{R}$ ;  $\ell: E \rightarrow \mathbb{R} \cup \{-\infty\}$ ,  $u: E \rightarrow \mathbb{R} \cup \{\infty\}$   
 $c: E \rightarrow \mathbb{R}$ ;

## Lemma 9 (without proof)

*A general mincost flow problem can be solved in polynomial time.*