

## 21 Gomory Hu Trees

Given an undirected, weighted graph  $G = (V, E, c)$  a **cut-tree**  $T = (V, F, w)$  is a tree with edge-set  $F$  and capacities  $w$  that fulfills the following properties.

- 1. Equivalent Flow Tree:** For any pair of vertices  $s, t \in V$ ,  $f(s, t)$  in  $G$  is equal to  $f_T(s, t)$ .
- 2. Cut Property:** A minimum  $s-t$  cut in  $T$  is also a minimum cut in  $G$ .

Here,  $f(s, t)$  is the value of a maximum  $s-t$  flow in  $G$ , and  $f_T(s, t)$  is the corresponding value in  $T$ .

# Overview of the Algorithm

The algorithm maintains a partition of  $V$ , (sets  $S_1, \dots, S_t$ ), and a spanning tree  $T$  on the vertex set  $\{S_1, \dots, S_t\}$ .

# Overview of the Algorithm

The algorithm maintains a partition of  $V$ , (sets  $S_1, \dots, S_t$ ), and a spanning tree  $T$  on the vertex set  $\{S_1, \dots, S_t\}$ .

Initially, there exists only the set  $S_1 = V$ .

# Overview of the Algorithm

The algorithm maintains a partition of  $V$ , (sets  $S_1, \dots, S_t$ ), and a spanning tree  $T$  on the vertex set  $\{S_1, \dots, S_t\}$ .

Initially, there exists only the set  $S_1 = V$ .

Then the algorithm performs  $n - 1$  split-operations:

# Overview of the Algorithm

The algorithm maintains a partition of  $V$ , (sets  $S_1, \dots, S_t$ ), and a spanning tree  $T$  on the vertex set  $\{S_1, \dots, S_t\}$ .

Initially, there exists only the set  $S_1 = V$ .

Then the algorithm performs  $n - 1$  split-operations:

- ▶ In each such split-operation it chooses a set  $S_i$  with  $|S_i| \geq 2$  and splits this set into two non-empty parts  $X$  and  $Y$ .

# Overview of the Algorithm

The algorithm maintains a partition of  $V$ , (sets  $S_1, \dots, S_t$ ), and a spanning tree  $T$  on the vertex set  $\{S_1, \dots, S_t\}$ .

Initially, there exists only the set  $S_1 = V$ .

Then the algorithm performs  $n - 1$  split-operations:

- ▶ In each such split-operation it chooses a set  $S_i$  with  $|S_i| \geq 2$  and splits this set into two non-empty parts  $X$  and  $Y$ .
- ▶  $S_i$  is then removed from  $T$  and replaced by  $X$  and  $Y$ .

# Overview of the Algorithm

The algorithm maintains a partition of  $V$ , (sets  $S_1, \dots, S_t$ ), and a spanning tree  $T$  on the vertex set  $\{S_1, \dots, S_t\}$ .

Initially, there exists only the set  $S_1 = V$ .

Then the algorithm performs  $n - 1$  split-operations:

- ▶ In each such split-operation it chooses a set  $S_i$  with  $|S_i| \geq 2$  and splits this set into two non-empty parts  $X$  and  $Y$ .
- ▶  $S_i$  is then removed from  $T$  and replaced by  $X$  and  $Y$ .
- ▶  $X$  and  $Y$  are connected by an edge, and the edges that before the split were incident to  $S_i$  are attached to either  $X$  or  $Y$ .

# Overview of the Algorithm

The algorithm maintains a partition of  $V$ , (sets  $S_1, \dots, S_t$ ), and a spanning tree  $T$  on the vertex set  $\{S_1, \dots, S_t\}$ .

Initially, there exists only the set  $S_1 = V$ .

Then the algorithm performs  $n - 1$  split-operations:

- ▶ In each such split-operation it chooses a set  $S_i$  with  $|S_i| \geq 2$  and splits this set into two non-empty parts  $X$  and  $Y$ .
- ▶  $S_i$  is then removed from  $T$  and replaced by  $X$  and  $Y$ .
- ▶  $X$  and  $Y$  are connected by an edge, and the edges that before the split were incident to  $S_i$  are attached to either  $X$  or  $Y$ .

**In the end this gives a tree on the vertex set  $V$ .**



## Details of the Split-operation

- ▶ Select  $S_i$  that contains at least two nodes  $a$  and  $b$ .

## Details of the Split-operation

- ▶ Select  $S_i$  that contains at least two nodes  $a$  and  $b$ .
- ▶ Compute the connected components of the forest obtained from the current tree  $T$  after deleting  $S_i$ . Each of these components corresponds to a set of vertices from  $V$ .

## Details of the Split-operation

- ▶ Select  $S_i$  that contains at least two nodes  $a$  and  $b$ .
- ▶ Compute the connected components of the forest obtained from the current tree  $T$  after deleting  $S_i$ . Each of these components corresponds to a set of vertices from  $V$ .
- ▶ Consider the graph  $H$  obtained from  $G$  by contracting these connected components into single nodes.

## Details of the Split-operation

- ▶ Select  $S_i$  that contains at least two nodes  $a$  and  $b$ .
- ▶ Compute the connected components of the forest obtained from the current tree  $T$  after deleting  $S_i$ . Each of these components corresponds to a set of vertices from  $V$ .
- ▶ Consider the graph  $H$  obtained from  $G$  by contracting these connected components into single nodes.
- ▶ Compute a minimum  $a$ - $b$  cut in  $H$ . Let  $A$ , and  $B$  denote the two sides of this cut.

## Details of the Split-operation

- ▶ Select  $S_i$  that contains at least two nodes  $a$  and  $b$ .
- ▶ Compute the connected components of the forest obtained from the current tree  $T$  after deleting  $S_i$ . Each of these components corresponds to a set of vertices from  $V$ .
- ▶ Consider the graph  $H$  obtained from  $G$  by contracting these connected components into single nodes.
- ▶ Compute a minimum  $a$ - $b$  cut in  $H$ . Let  $A$ , and  $B$  denote the two sides of this cut.
- ▶ Split  $S_i$  in  $T$  into two sets/nodes  $S_i^a := S_i \cap A$  and  $S_i^b := S_i \cap B$  and add edge  $\{S_i^a, S_i^b\}$  with capacity  $f_H(a, b)$ .

## Details of the Split-operation

- ▶ Select  $S_i$  that contains at least two nodes  $a$  and  $b$ .
- ▶ Compute the connected components of the forest obtained from the current tree  $T$  after deleting  $S_i$ . Each of these components corresponds to a set of vertices from  $V$ .
- ▶ Consider the graph  $H$  obtained from  $G$  by contracting these connected components into single nodes.
- ▶ Compute a minimum  $a$ - $b$  cut in  $H$ . Let  $A$ , and  $B$  denote the two sides of this cut.
- ▶ Split  $S_i$  in  $T$  into two sets/nodes  $S_i^a := S_i \cap A$  and  $S_i^b := S_i \cap B$  and add edge  $\{S_i^a, S_i^b\}$  with capacity  $f_H(a, b)$ .
- ▶ Replace an edge  $\{S_i, S_x\}$  by  $\{S_i^a, S_x\}$  if  $S_x \subset A$  and by  $\{S_i^b, S_x\}$  if  $S_x \subset B$ .

# Example: Gomory-Hu Construction

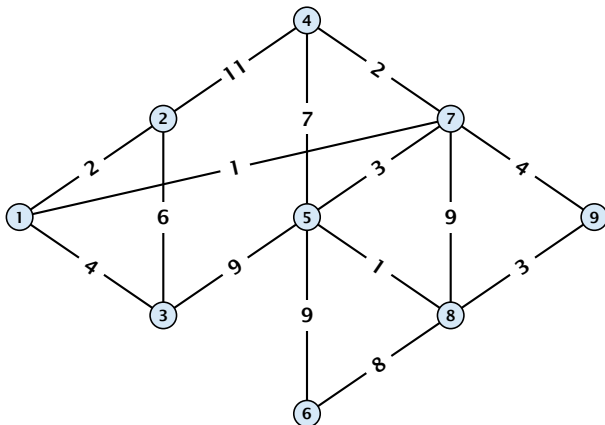

# Example: Gomory-Hu Construction

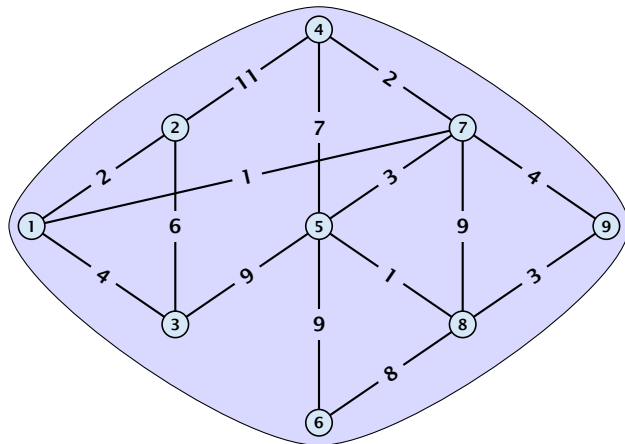



# Example: Gomory-Hu Construction

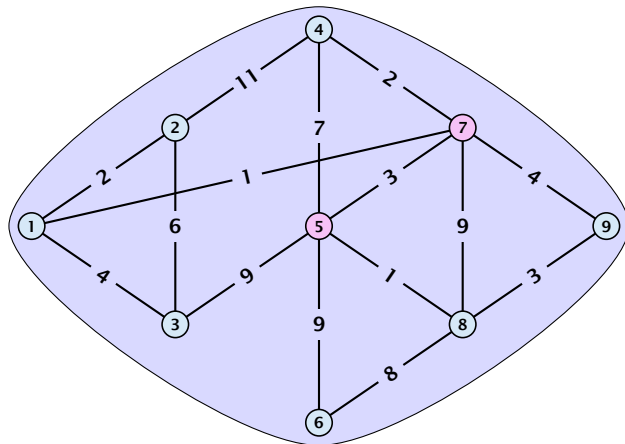

# Example: Gomory-Hu Construction

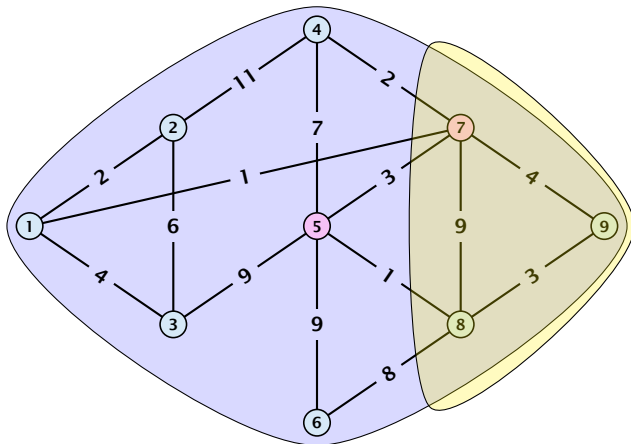

# Example: Gomory-Hu Construction

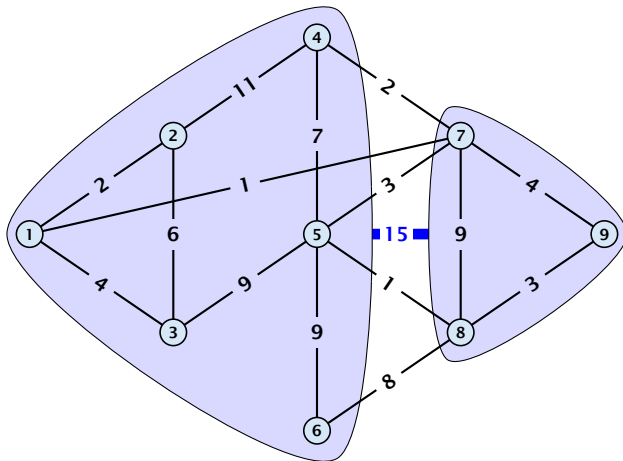

# Example: Gomory-Hu Construction

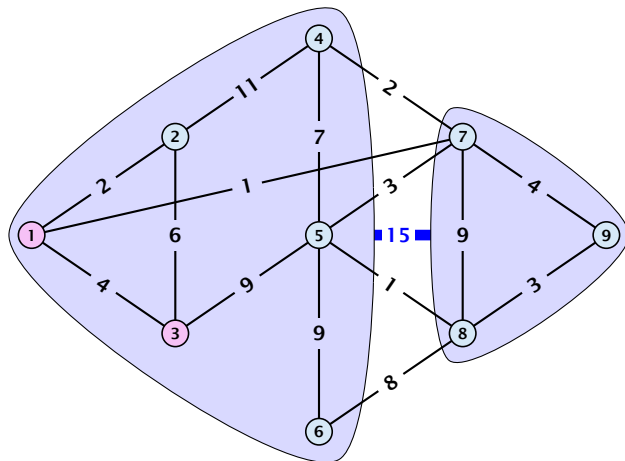

# Example: Gomory-Hu Construction

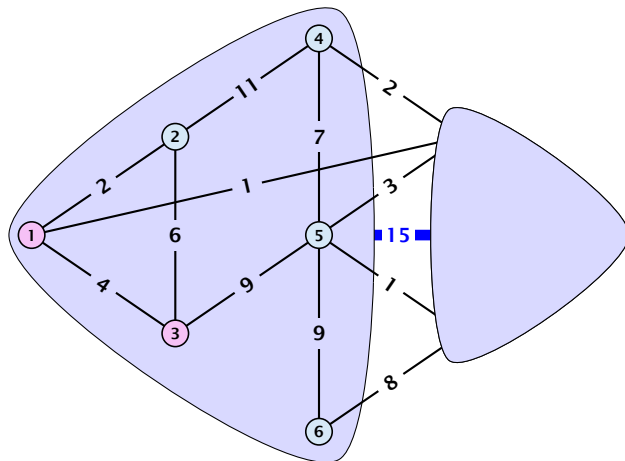

# Example: Gomory-Hu Construction

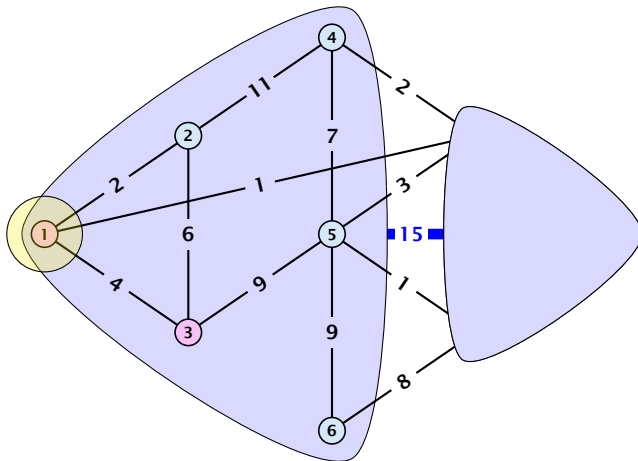

# Example: Gomory-Hu Construction

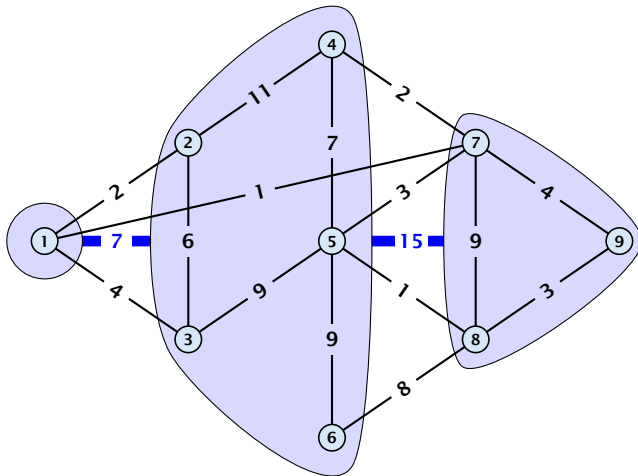

# Example: Gomory-Hu Construction

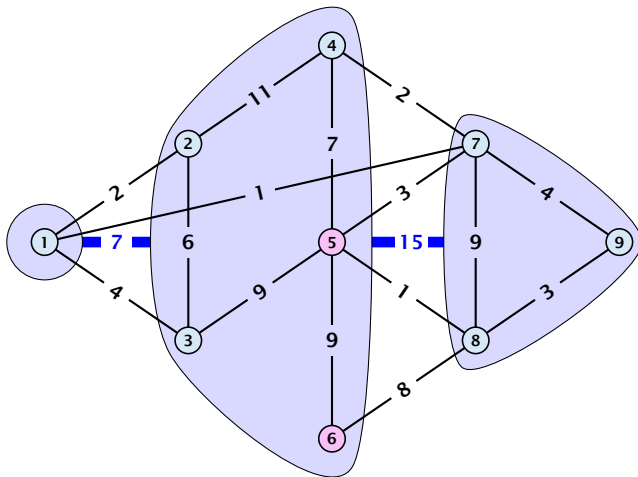



# Example: Gomory-Hu Construction

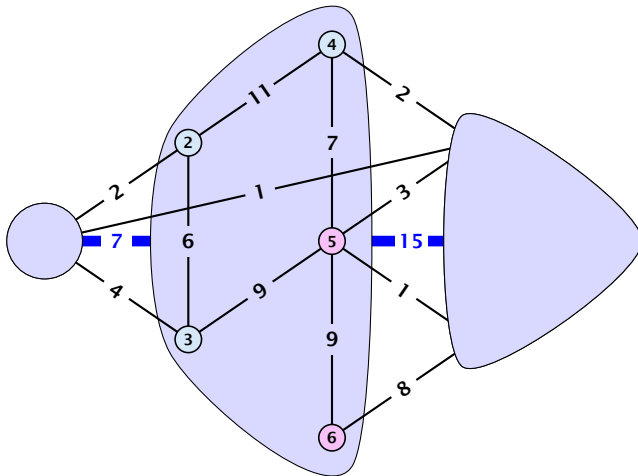

# Example: Gomory-Hu Construction

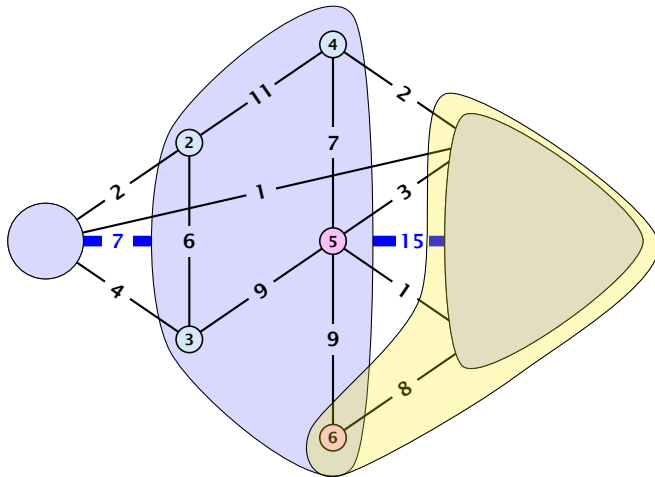

# Example: Gomory-Hu Construction

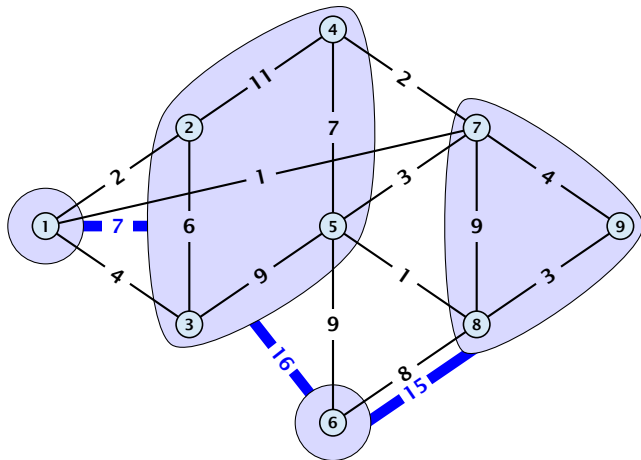

# Example: Gomory-Hu Construction

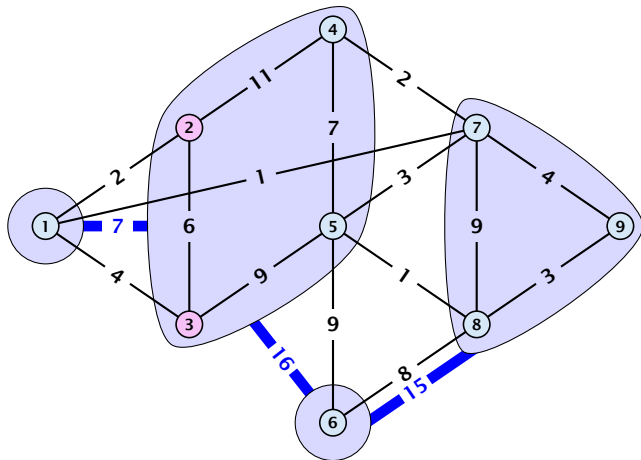

# Example: Gomory-Hu Construction

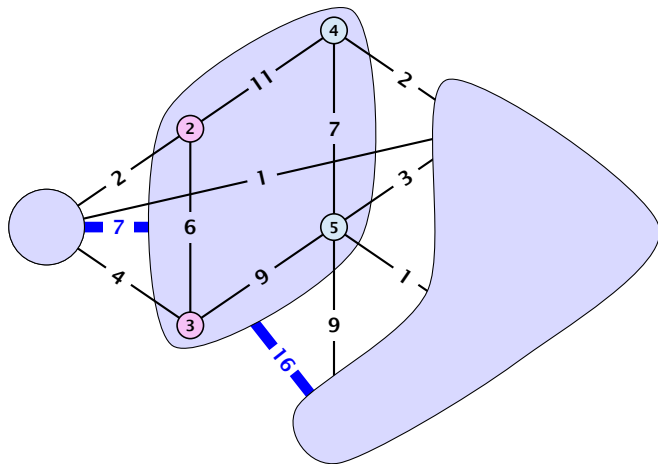

# Example: Gomory-Hu Construction

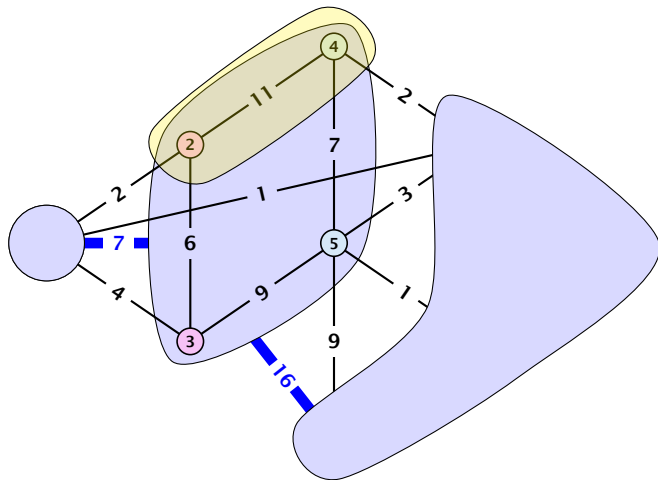

# Example: Gomory-Hu Construction

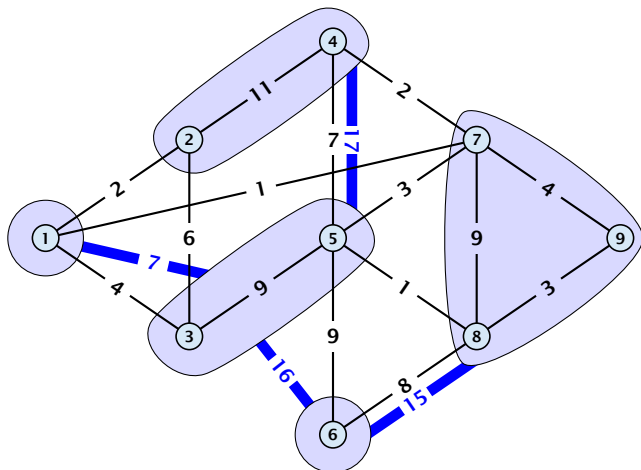

# Example: Gomory-Hu Construction

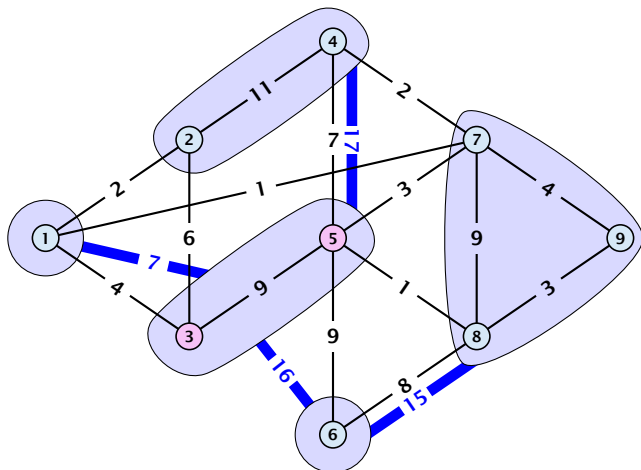



## Example: Gomory-Hu Construction

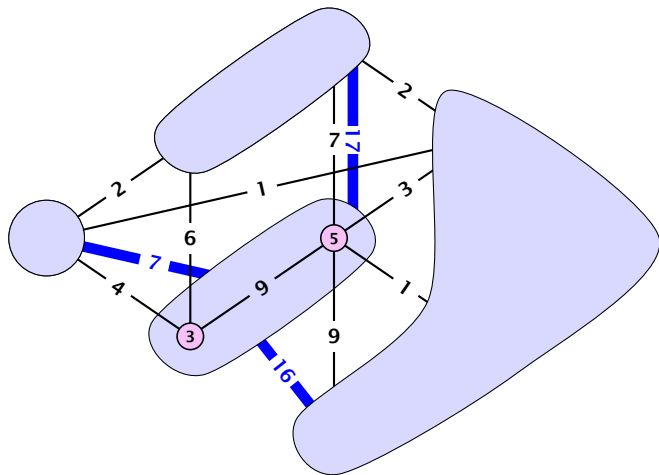

# Example: Gomory-Hu Construction

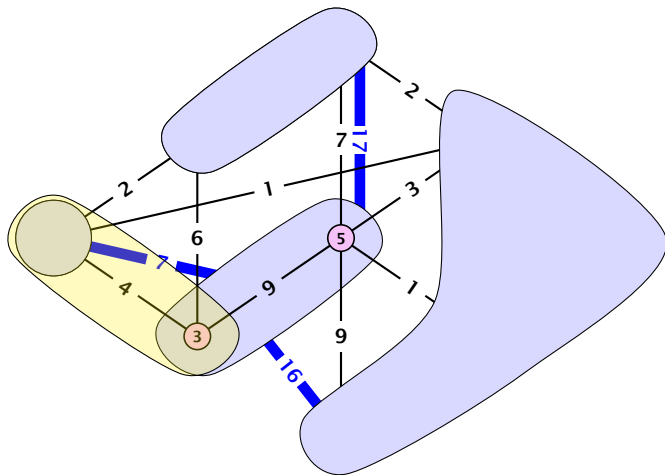

# Example: Gomory-Hu Construction

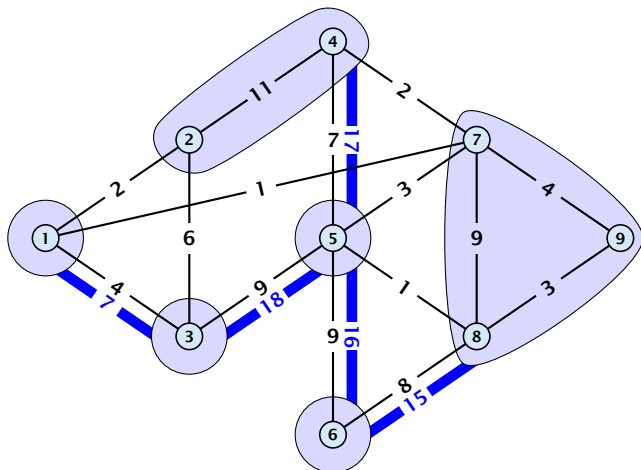

# Example: Gomory-Hu Construction

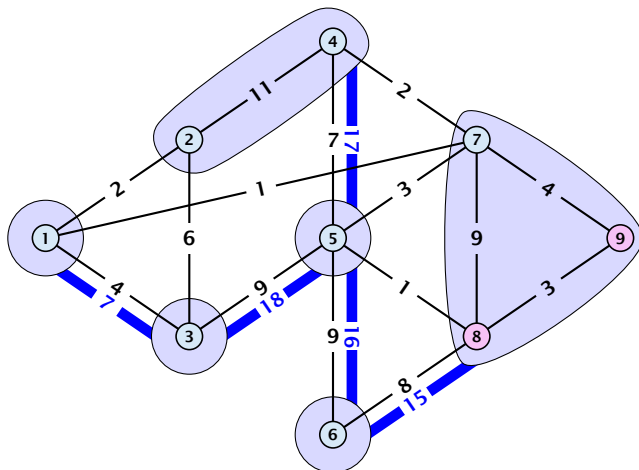

# Example: Gomory-Hu Construction

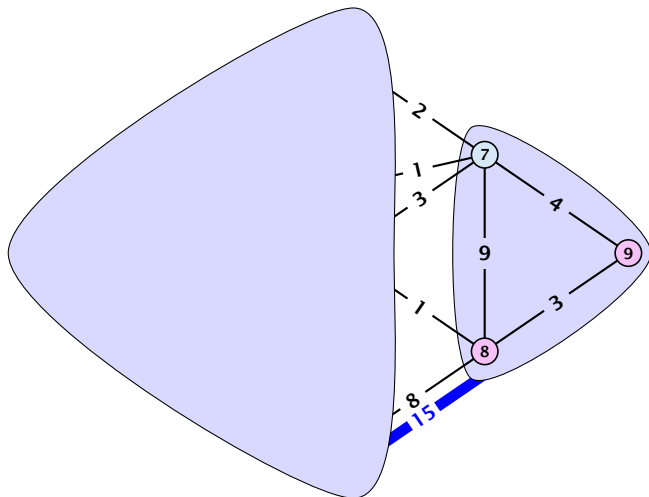

# Example: Gomory-Hu Construction

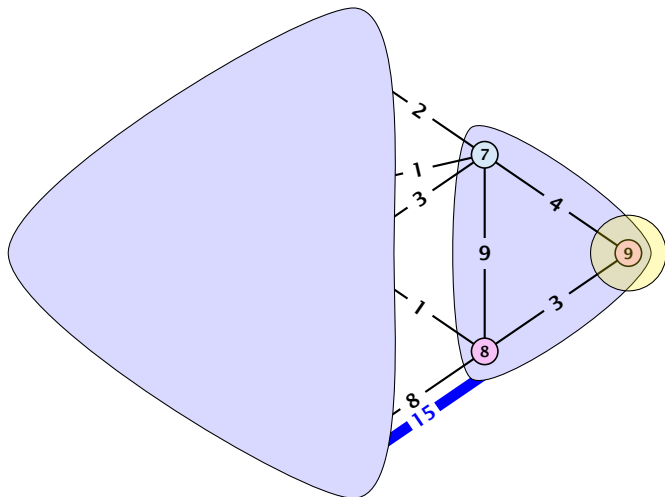

# Example: Gomory-Hu Construction

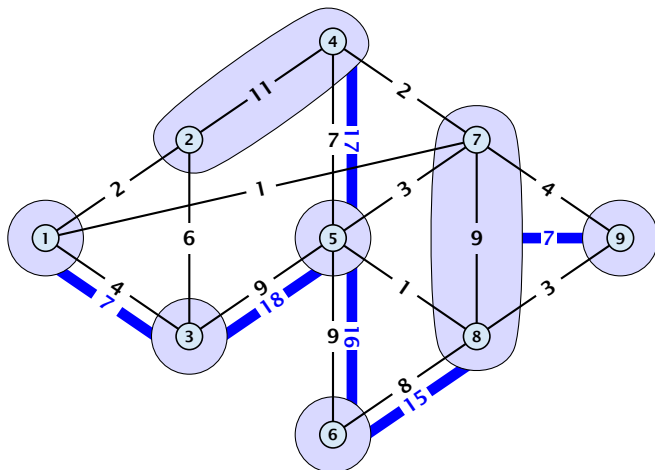

# Example: Gomory-Hu Construction

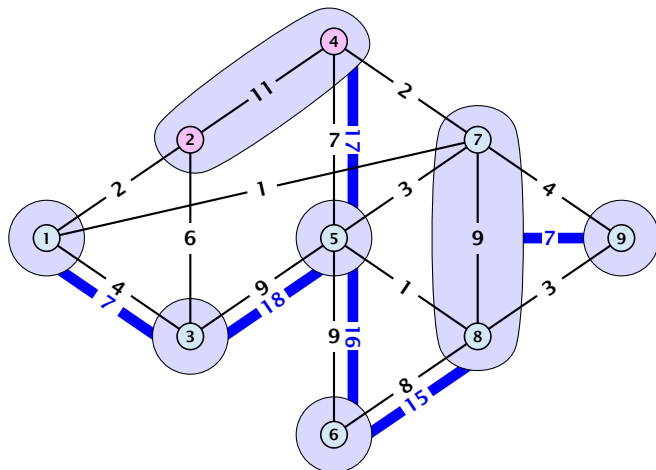



# Example: Gomory-Hu Construction

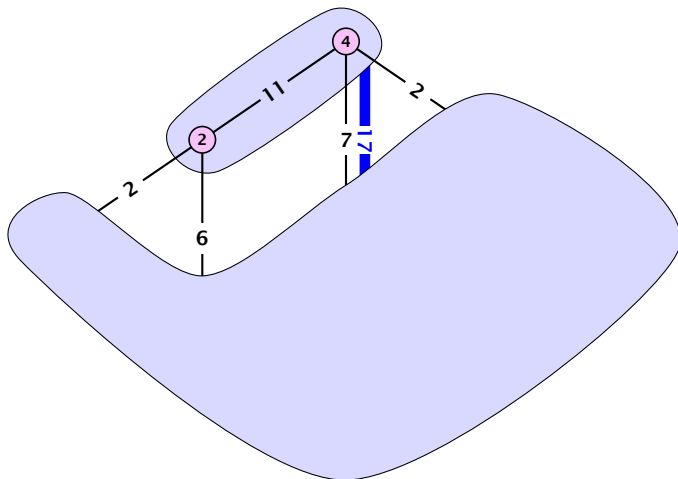

# Example: Gomory-Hu Construction

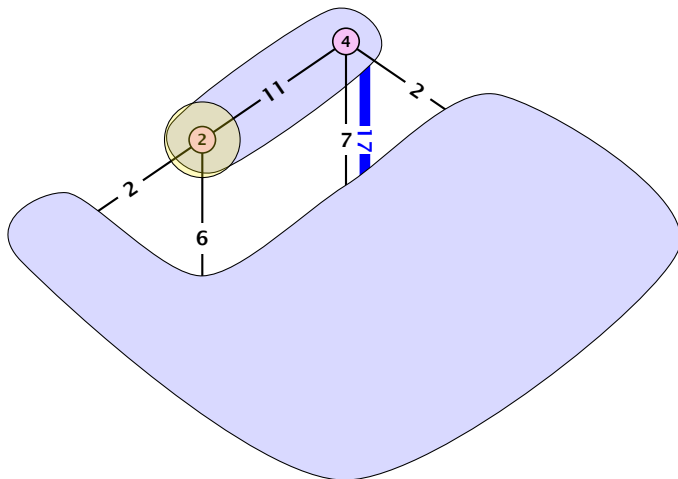

# Example: Gomory-Hu Construction

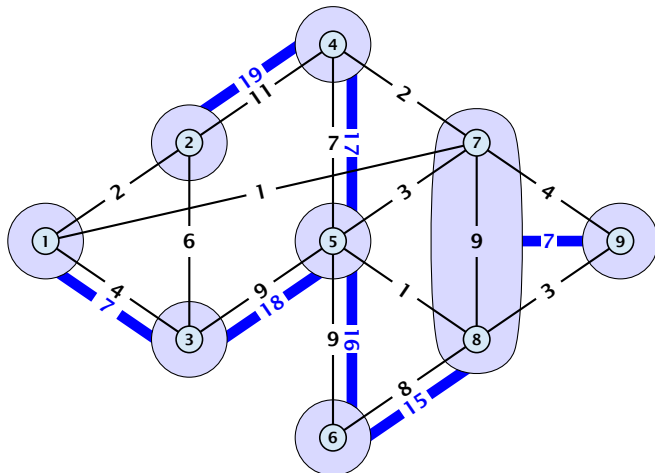

# Example: Gomory-Hu Construction

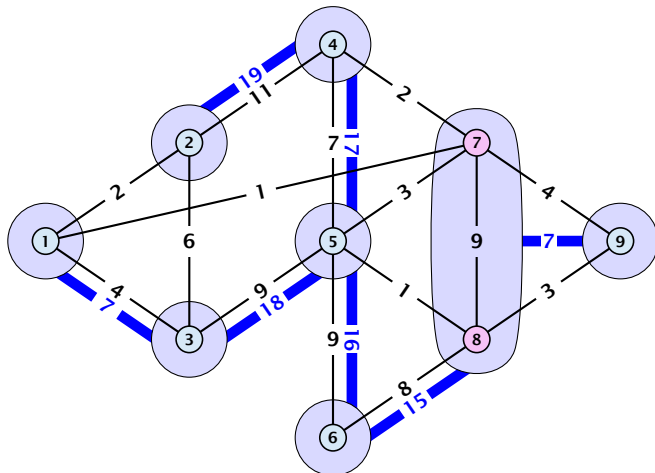

# Example: Gomory-Hu Construction

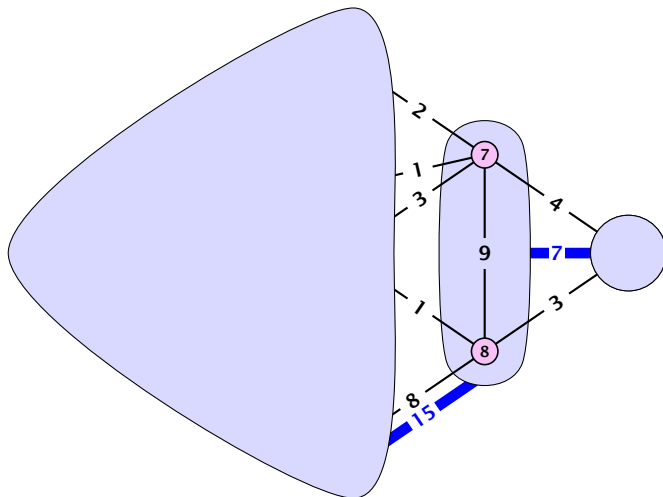

# Example: Gomory-Hu Construction

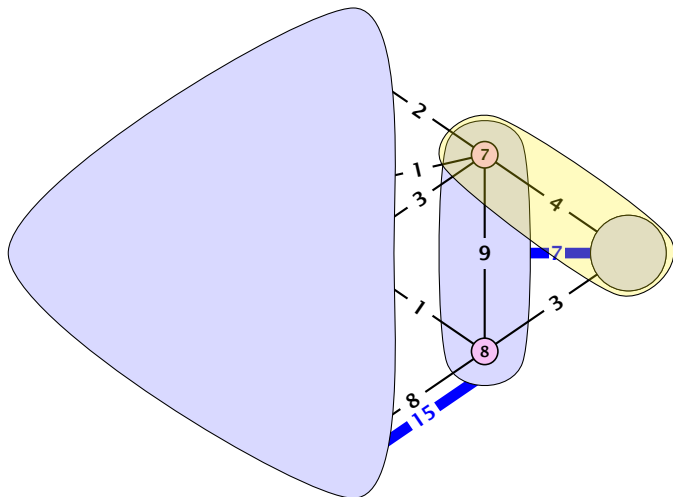

# Example: Gomory-Hu Construction

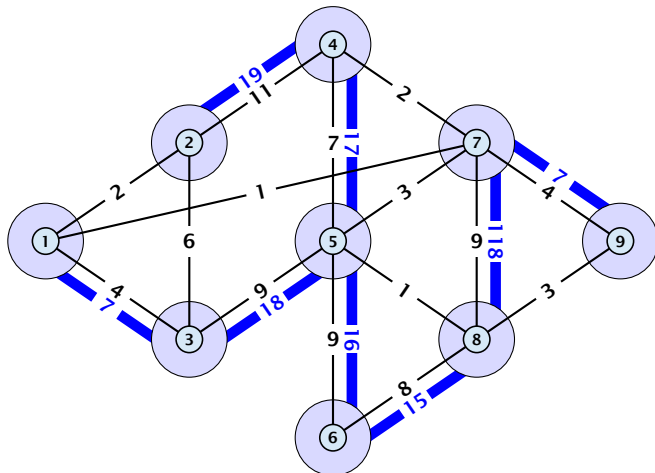

## Lemma 6

For nodes  $s, t, x \in V$  we have  $f(s, t) \geq \min\{f(s, x), f(x, t)\}$



## Lemma 6

For nodes  $s, t, x \in V$  we have  $f(s, t) \geq \min\{f(s, x), f(x, t)\}$

## Lemma 7

For nodes  $s, t, x_1, \dots, x_k \in V$  we have

$f(s, t) \geq \min\{f(s, x_1), f(x_1, x_2), \dots, f(x_{k-1}, x_k), f(x_k, t)\}$

## Lemma 8

Let  $S$  be some minimum  $r$ - $s$  cut for some nodes  $r, s \in V$  ( $s \in S$ ), and let  $v, w \in S$ . Then there is a minimum  $v$ - $w$ -cut  $T$  with  $T \subset S$ .

## Lemma 8

Let  $S$  be some minimum  $r$ - $s$  cut for some nodes  $r, s \in V$  ( $s \in S$ ), and let  $v, w \in S$ . Then there is a minimum  $v$ - $w$ -cut  $T$  with  $T \subset S$ .

**Proof:** Let  $X$  be a minimum  $v$ - $w$  cut with  $X \cap S \neq \emptyset$  and  $X \cap (V \setminus S) \neq \emptyset$ .

## Lemma 8

Let  $S$  be some minimum  $r$ - $s$  cut for some nodes  $r, s \in V$  ( $s \in S$ ), and let  $v, w \in S$ . Then there is a minimum  $v$ - $w$ -cut  $T$  with  $T \subset S$ .

**Proof:** Let  $X$  be a minimum  $v$ - $w$  cut with  $X \cap S \neq \emptyset$  and  $X \cap (V \setminus S) \neq \emptyset$ . Note that  $S \setminus X$  and  $S \cap X$  are  $v$ - $w$  cuts inside  $S$ .

## Lemma 8

Let  $S$  be some minimum  $r$ - $s$  cut for some nodes  $r, s \in V$  ( $s \in S$ ), and let  $v, w \in S$ . Then there is a minimum  $v$ - $w$ -cut  $T$  with  $T \subset S$ .

**Proof:** Let  $X$  be a minimum  $v$ - $w$  cut with  $X \cap S \neq \emptyset$  and  $X \cap (V \setminus S) \neq \emptyset$ . Note that  $S \setminus X$  and  $S \cap X$  are  $v$ - $w$  cuts inside  $S$ .

We may assume w.l.o.g.  $s \in X$ .

## Lemma 8

Let  $S$  be some minimum  $r$ - $s$  cut for some nodes  $r, s \in V$  ( $s \in S$ ), and let  $v, w \in S$ . Then there is a minimum  $v$ - $w$ -cut  $T$  with  $T \subset S$ .

**Proof:** Let  $X$  be a minimum  $v$ - $w$  cut with  $X \cap S \neq \emptyset$  and  $X \cap (V \setminus S) \neq \emptyset$ . Note that  $S \setminus X$  and  $S \cap X$  are  $v$ - $w$  cuts inside  $S$ .

We may assume w.l.o.g.  $s \in X$ .

**First case**  $r \in X$ .

## Lemma 8

Let  $S$  be some minimum  $r$ - $s$  cut for some nodes  $r, s \in V$  ( $s \in S$ ), and let  $v, w \in S$ . Then there is a minimum  $v$ - $w$ -cut  $T$  with  $T \subset S$ .

**Proof:** Let  $X$  be a minimum  $v$ - $w$  cut with  $X \cap S \neq \emptyset$  and  $X \cap (V \setminus S) \neq \emptyset$ . Note that  $S \setminus X$  and  $S \cap X$  are  $v$ - $w$  cuts inside  $S$ .

We may assume w.l.o.g.  $s \in X$ .

**First case**  $r \in X$ .

▶  $\text{cap}(X \setminus S) + \text{cap}(S \setminus X) \leq \text{cap}(S) + \text{cap}(X)$ .

## Lemma 8

Let  $S$  be some minimum  $r$ - $s$  cut for some nodes  $r, s \in V$  ( $s \in S$ ), and let  $v, w \in S$ . Then there is a minimum  $v$ - $w$ -cut  $T$  with  $T \subset S$ .

**Proof:** Let  $X$  be a minimum  $v$ - $w$  cut with  $X \cap S \neq \emptyset$  and  $X \cap (V \setminus S) \neq \emptyset$ . Note that  $S \setminus X$  and  $S \cap X$  are  $v$ - $w$  cuts inside  $S$ .

We may assume w.l.o.g.  $s \in X$ .

**First case  $r \in X$ .**

- ▶  $\text{cap}(X \setminus S) + \text{cap}(S \setminus X) \leq \text{cap}(S) + \text{cap}(X)$ .
- ▶  $\text{cap}(X \setminus S) \geq \text{cap}(S)$  because  $X \setminus S$  is an  $r$ - $s$  cut.



## Lemma 8

Let  $S$  be some minimum  $r$ - $s$  cut for some nodes  $r, s \in V$  ( $s \in S$ ), and let  $v, w \in S$ . Then there is a minimum  $v$ - $w$ -cut  $T$  with  $T \subset S$ .

**Proof:** Let  $X$  be a minimum  $v$ - $w$  cut with  $X \cap S \neq \emptyset$  and  $X \cap (V \setminus S) \neq \emptyset$ . Note that  $S \setminus X$  and  $S \cap X$  are  $v$ - $w$  cuts inside  $S$ .

We may assume w.l.o.g.  $s \in X$ .

**First case  $r \in X$ .**

- ▶  $\text{cap}(X \setminus S) + \text{cap}(S \setminus X) \leq \text{cap}(S) + \text{cap}(X)$ .
- ▶  $\text{cap}(X \setminus S) \geq \text{cap}(S)$  because  $X \setminus S$  is an  $r$ - $s$  cut.
- ▶ This gives  $\text{cap}(S \setminus X) \leq \text{cap}(X)$ .

## Lemma 8

Let  $S$  be some minimum  $r$ - $s$  cut for some nodes  $r, s \in V$  ( $s \in S$ ), and let  $v, w \in S$ . Then there is a minimum  $v$ - $w$ -cut  $T$  with  $T \subset S$ .

**Proof:** Let  $X$  be a minimum  $v$ - $w$  cut with  $X \cap S \neq \emptyset$  and  $X \cap (V \setminus S) \neq \emptyset$ . Note that  $S \setminus X$  and  $S \cap X$  are  $v$ - $w$  cuts inside  $S$ .

We may assume w.l.o.g.  $s \in X$ .

**First case  $r \in X$ .**

- ▶  $\text{cap}(X \setminus S) + \text{cap}(S \setminus X) \leq \text{cap}(S) + \text{cap}(X)$ .
- ▶  $\text{cap}(X \setminus S) \geq \text{cap}(S)$  because  $X \setminus S$  is an  $r$ - $s$  cut.
- ▶ This gives  $\text{cap}(S \setminus X) \leq \text{cap}(X)$ .

**Second case  $r \notin X$ .**

## Lemma 8

Let  $S$  be some minimum  $r$ - $s$  cut for some nodes  $r, s \in V$  ( $s \in S$ ), and let  $v, w \in S$ . Then there is a minimum  $v$ - $w$ -cut  $T$  with  $T \subset S$ .

**Proof:** Let  $X$  be a minimum  $v$ - $w$  cut with  $X \cap S \neq \emptyset$  and  $X \cap (V \setminus S) \neq \emptyset$ . Note that  $S \setminus X$  and  $S \cap X$  are  $v$ - $w$  cuts inside  $S$ .

We may assume w.l.o.g.  $s \in X$ .

**First case  $r \in X$ .**

- ▶  $\text{cap}(X \setminus S) + \text{cap}(S \setminus X) \leq \text{cap}(S) + \text{cap}(X)$ .
- ▶  $\text{cap}(X \setminus S) \geq \text{cap}(S)$  because  $X \setminus S$  is an  $r$ - $s$  cut.
- ▶ This gives  $\text{cap}(S \setminus X) \leq \text{cap}(X)$ .

**Second case  $r \notin X$ .**

- ▶  $\text{cap}(X \cup S) + \text{cap}(S \cap X) \leq \text{cap}(S) + \text{cap}(X)$ .

## Lemma 8

Let  $S$  be some minimum  $r$ - $s$  cut for some nodes  $r, s \in V$  ( $s \in S$ ), and let  $v, w \in S$ . Then there is a minimum  $v$ - $w$ -cut  $T$  with  $T \subset S$ .

**Proof:** Let  $X$  be a minimum  $v$ - $w$  cut with  $X \cap S \neq \emptyset$  and  $X \cap (V \setminus S) \neq \emptyset$ . Note that  $S \setminus X$  and  $S \cap X$  are  $v$ - $w$  cuts inside  $S$ .

We may assume w.l.o.g.  $s \in X$ .

**First case  $r \in X$ .**

- ▶  $\text{cap}(X \setminus S) + \text{cap}(S \setminus X) \leq \text{cap}(S) + \text{cap}(X)$ .
- ▶  $\text{cap}(X \setminus S) \geq \text{cap}(S)$  because  $X \setminus S$  is an  $r$ - $s$  cut.
- ▶ This gives  $\text{cap}(S \setminus X) \leq \text{cap}(X)$ .

**Second case  $r \notin X$ .**

- ▶  $\text{cap}(X \cup S) + \text{cap}(S \cap X) \leq \text{cap}(S) + \text{cap}(X)$ .
- ▶  $\text{cap}(X \cup S) \geq \text{cap}(S)$  because  $X \cup S$  is an  $r$ - $s$  cut.

## Lemma 8

Let  $S$  be some minimum  $r$ - $s$  cut for some nodes  $r, s \in V$  ( $s \in S$ ), and let  $v, w \in S$ . Then there is a minimum  $v$ - $w$ -cut  $T$  with  $T \subset S$ .

**Proof:** Let  $X$  be a minimum  $v$ - $w$  cut with  $X \cap S \neq \emptyset$  and  $X \cap (V \setminus S) \neq \emptyset$ . Note that  $S \setminus X$  and  $S \cap X$  are  $v$ - $w$  cuts inside  $S$ .

We may assume w.l.o.g.  $s \in X$ .

**First case  $r \in X$ .**

- ▶  $\text{cap}(X \setminus S) + \text{cap}(S \setminus X) \leq \text{cap}(S) + \text{cap}(X)$ .
- ▶  $\text{cap}(X \setminus S) \geq \text{cap}(S)$  because  $X \setminus S$  is an  $r$ - $s$  cut.
- ▶ This gives  $\text{cap}(S \setminus X) \leq \text{cap}(X)$ .

**Second case  $r \notin X$ .**

- ▶  $\text{cap}(X \cup S) + \text{cap}(S \cap X) \leq \text{cap}(S) + \text{cap}(X)$ .
- ▶  $\text{cap}(X \cup S) \geq \text{cap}(S)$  because  $X \cup S$  is an  $r$ - $s$  cut.
- ▶ This gives  $\text{cap}(S \cap X) \leq \text{cap}(X)$ .

$$\text{cap}(S \setminus X) + \text{cap}(X \setminus S) \leq \text{cap}(S) + \text{cap}(X)$$

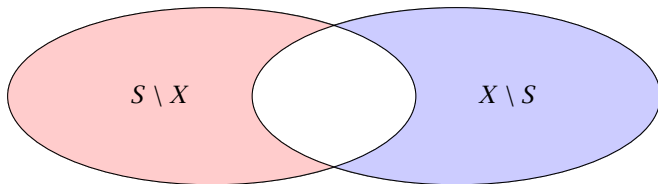
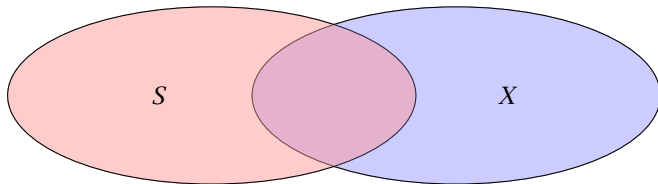

$$\text{cap}(S \setminus X) + \text{cap}(X \setminus S) \leq \text{cap}(S) + \text{cap}(X)$$

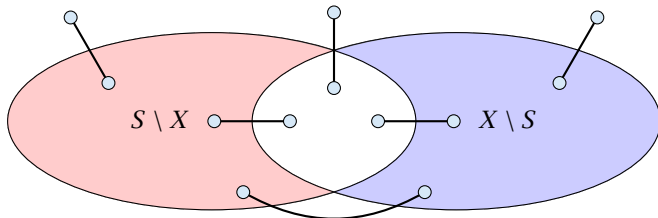
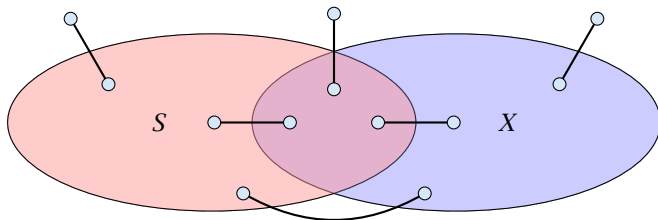

$$\text{cap}(S \setminus X) + \text{cap}(X \setminus S) \leq \text{cap}(S) + \text{cap}(X)$$

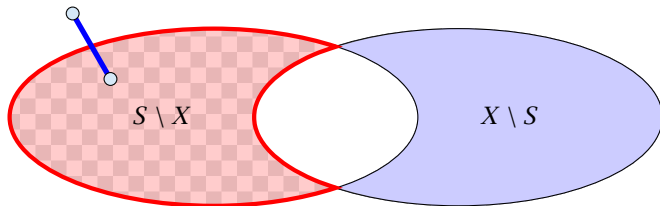
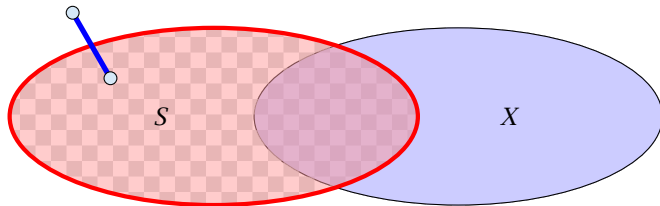



$$\text{cap}(S \setminus X) + \text{cap}(X \setminus S) \leq \text{cap}(S) + \text{cap}(X)$$

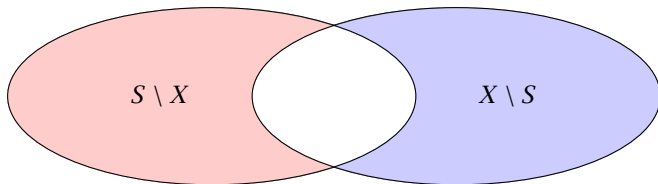
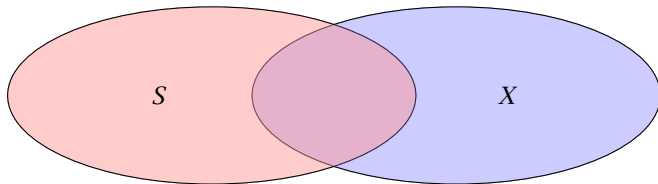

$$\text{cap}(S \setminus X) + \text{cap}(X \setminus S) \leq \text{cap}(S) + \text{cap}(X)$$

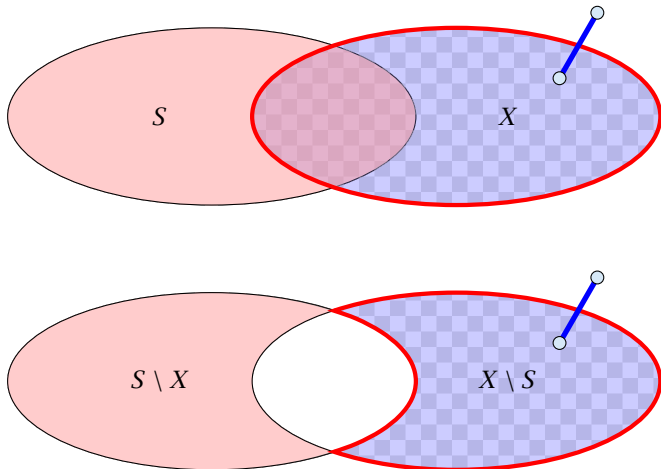

$$\text{cap}(S \setminus X) + \text{cap}(X \setminus S) \leq \text{cap}(S) + \text{cap}(X)$$

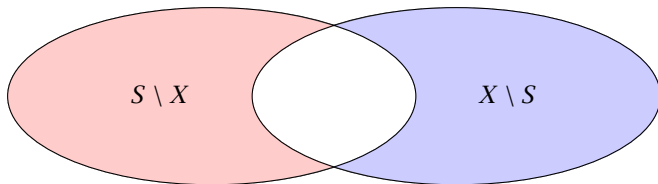
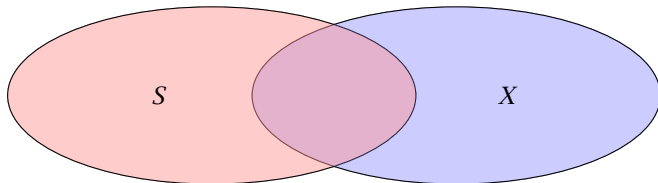

$$\text{cap}(S \setminus X) + \text{cap}(X \setminus S) \leq \text{cap}(S) + \text{cap}(X)$$

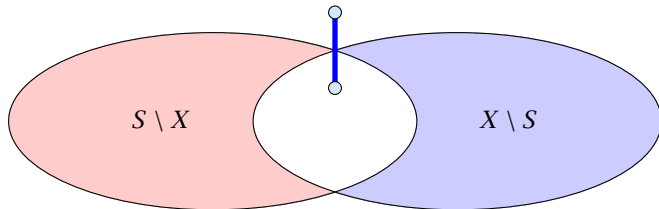
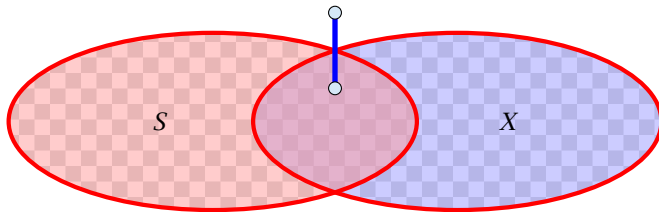

$$\text{cap}(S \setminus X) + \text{cap}(X \setminus S) \leq \text{cap}(S) + \text{cap}(X)$$

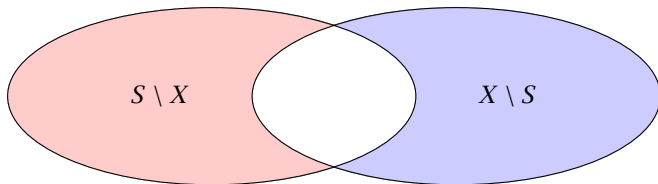
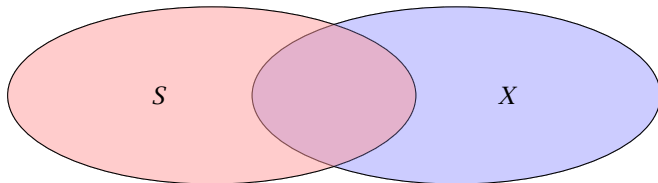

$$\text{cap}(S \setminus X) + \text{cap}(X \setminus S) \leq \text{cap}(S) + \text{cap}(X)$$

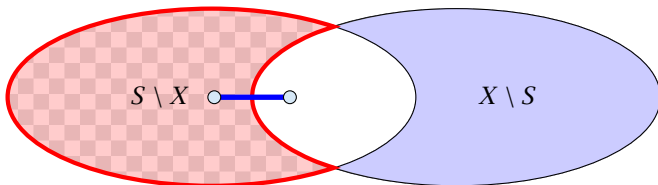
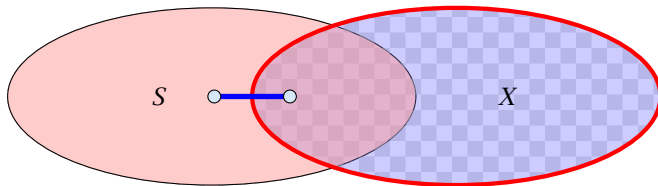

$$\text{cap}(S \setminus X) + \text{cap}(X \setminus S) \leq \text{cap}(S) + \text{cap}(X)$$

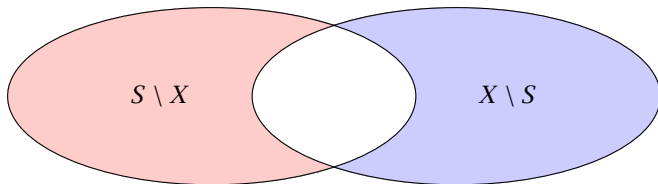
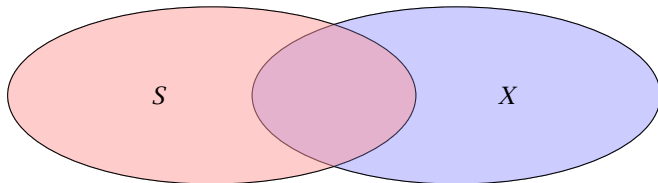

$$\text{cap}(S \setminus X) + \text{cap}(X \setminus S) \leq \text{cap}(S) + \text{cap}(X)$$

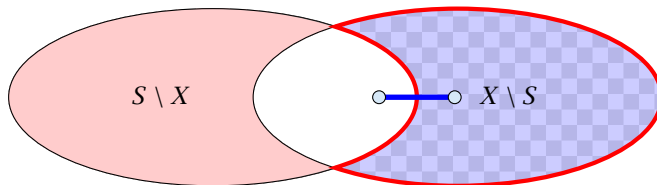
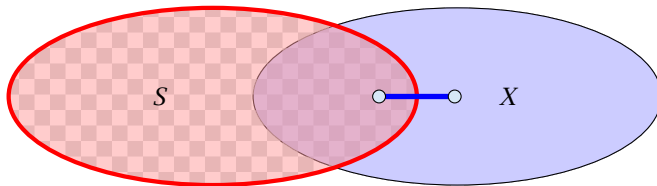



$$\text{cap}(S \setminus X) + \text{cap}(X \setminus S) \leq \text{cap}(S) + \text{cap}(X)$$

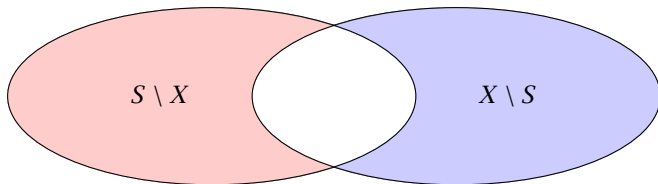
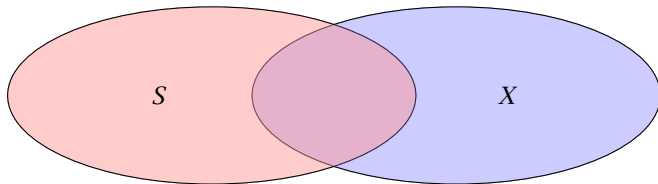

$$\text{cap}(S \setminus X) + \text{cap}(X \setminus S) \leq \text{cap}(S) + \text{cap}(X)$$

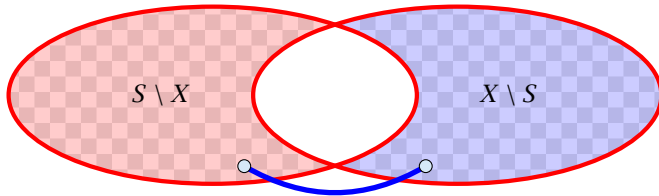
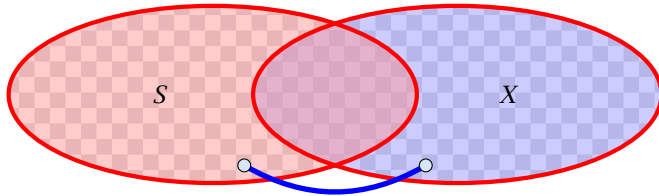

$$\text{cap}(S \setminus X) + \text{cap}(X \setminus S) \leq \text{cap}(S) + \text{cap}(X)$$

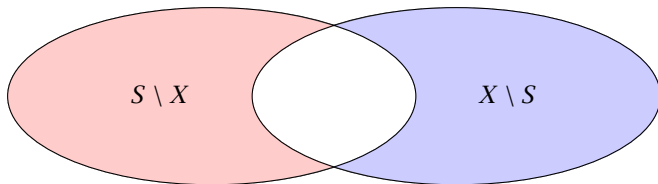
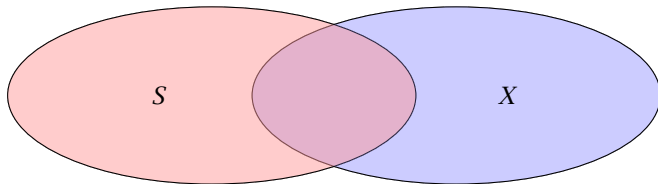

$$\text{cap}(S \setminus X) + \text{cap}(X \setminus S) \leq \text{cap}(S) + \text{cap}(X)$$

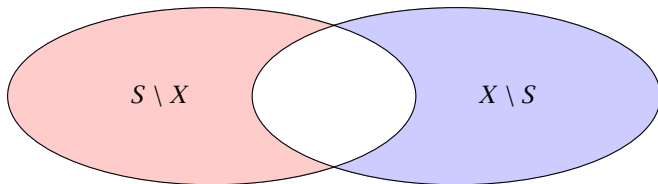
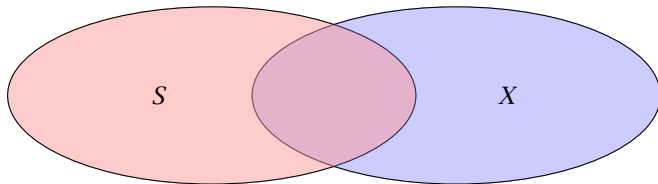

$$\text{cap}(X \cup S) + \text{cap}(S \cap X) \leq \text{cap}(S) + \text{cap}(X)$$

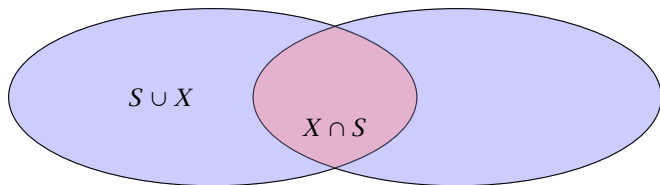
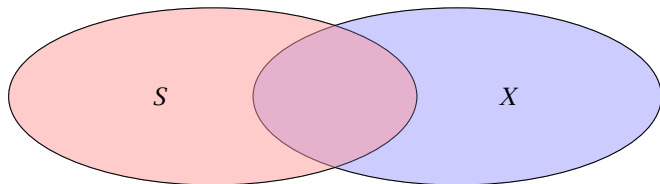

$$\text{cap}(X \cup S) + \text{cap}(S \cap X) \leq \text{cap}(S) + \text{cap}(X)$$

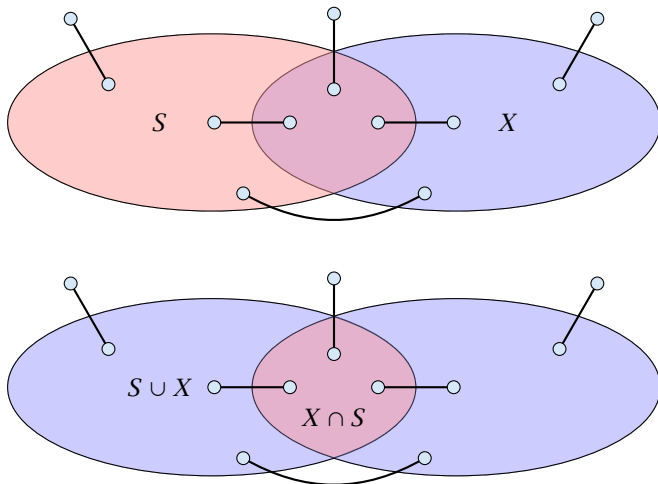

$$\text{cap}(X \cup S) + \text{cap}(S \cap X) \leq \text{cap}(S) + \text{cap}(X)$$

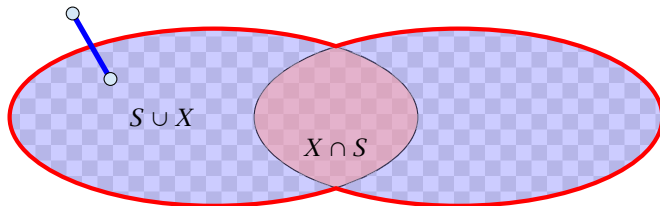
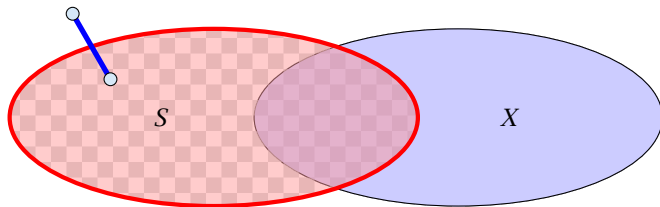

$$\text{cap}(X \cup S) + \text{cap}(S \cap X) \leq \text{cap}(S) + \text{cap}(X)$$

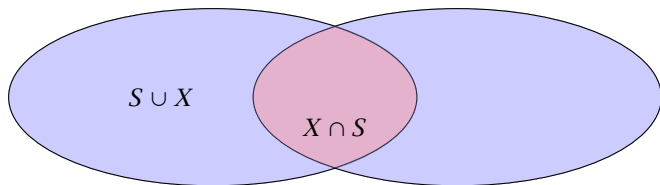
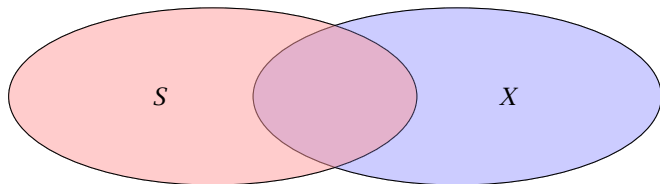



$$\text{cap}(X \cup S) + \text{cap}(S \cap X) \leq \text{cap}(S) + \text{cap}(X)$$

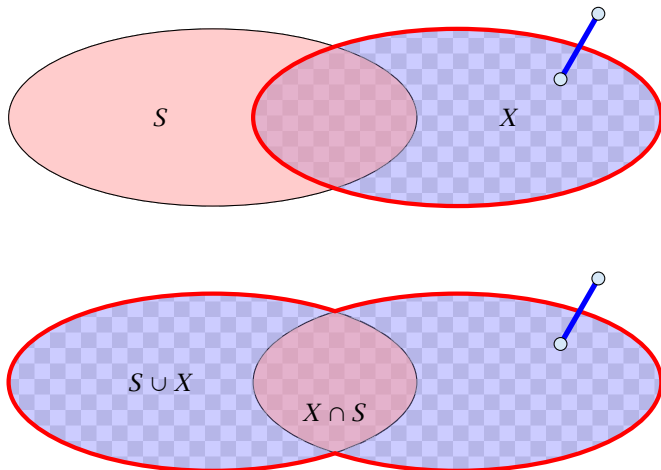

$$\text{cap}(X \cup S) + \text{cap}(S \cap X) \leq \text{cap}(S) + \text{cap}(X)$$

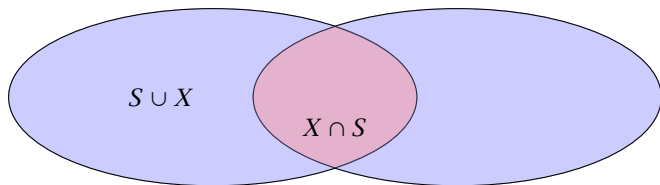
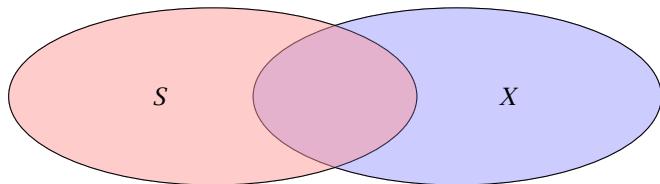

$$\text{cap}(X \cup S) + \text{cap}(S \cap X) \leq \text{cap}(S) + \text{cap}(X)$$

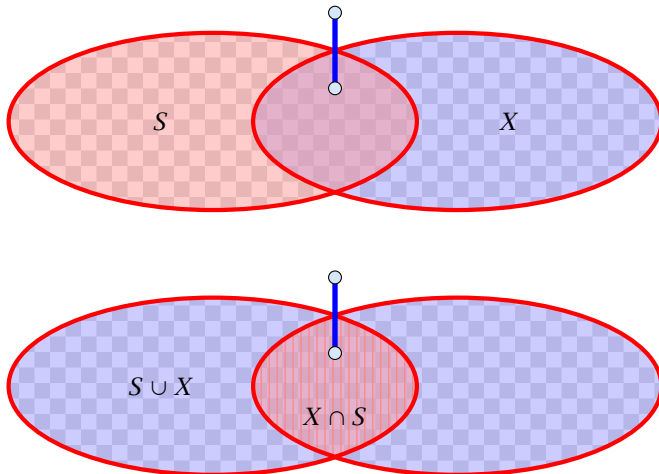

$$\text{cap}(X \cup S) + \text{cap}(S \cap X) \leq \text{cap}(S) + \text{cap}(X)$$

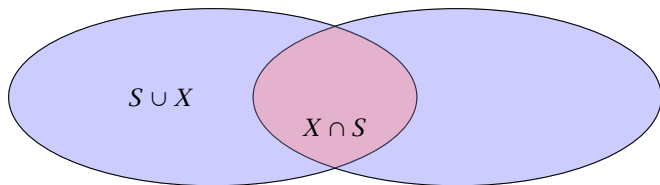
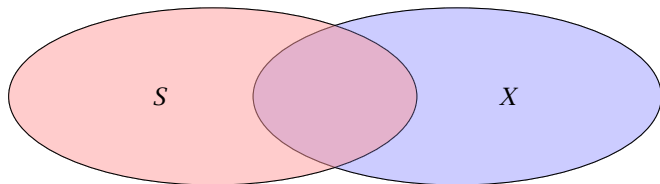

$$\text{cap}(X \cup S) + \text{cap}(S \cap X) \leq \text{cap}(S) + \text{cap}(X)$$

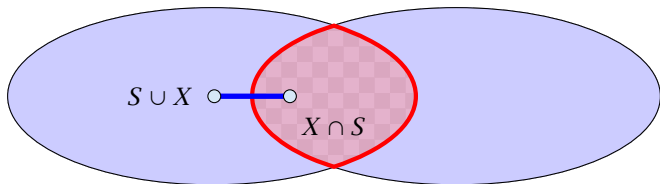
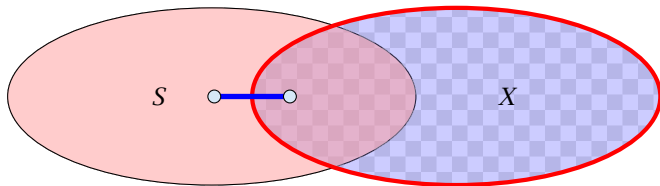

$$\text{cap}(X \cup S) + \text{cap}(S \cap X) \leq \text{cap}(S) + \text{cap}(X)$$

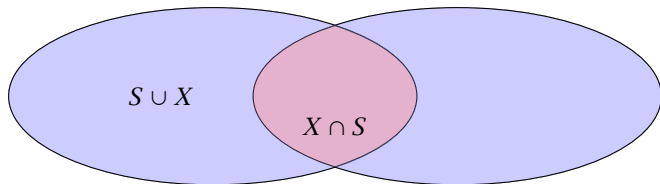
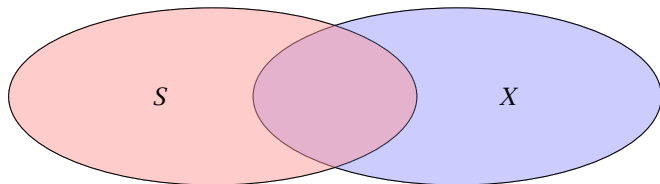

$$\text{cap}(X \cup S) + \text{cap}(S \cap X) \leq \text{cap}(S) + \text{cap}(X)$$

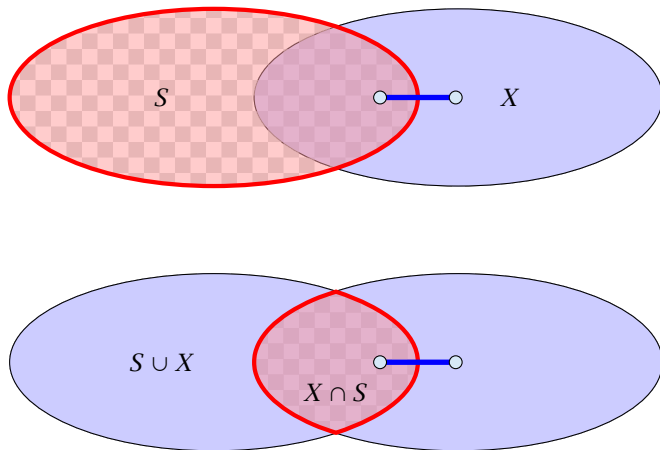

$$\text{cap}(X \cup S) + \text{cap}(S \cap X) \leq \text{cap}(S) + \text{cap}(X)$$

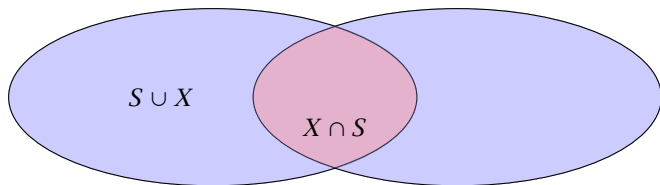
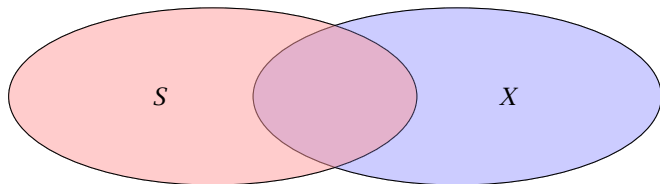



$$\text{cap}(X \cup S) + \text{cap}(S \cap X) \leq \text{cap}(S) + \text{cap}(X)$$

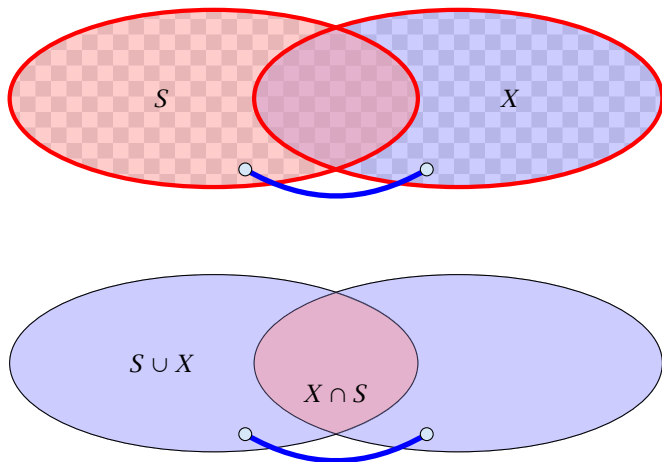

$$\text{cap}(X \cup S) + \text{cap}(S \cap X) \leq \text{cap}(S) + \text{cap}(X)$$

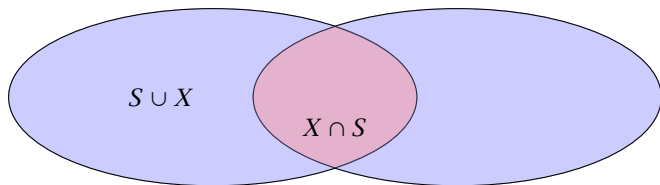
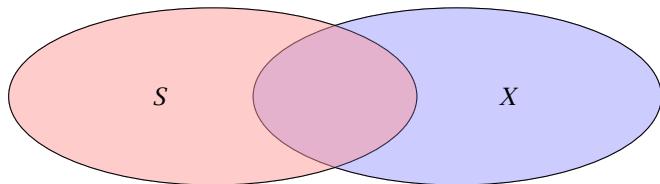

$$\text{cap}(X \cup S) + \text{cap}(S \cap X) \leq \text{cap}(S) + \text{cap}(X)$$

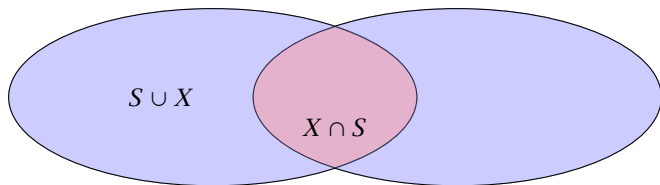
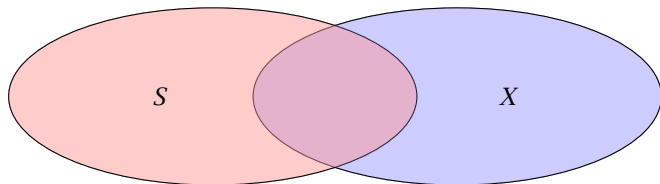

# Analysis

Lemma 8 tells us that if we have a graph  $G = (V, E)$  and we contract a subset  $X \subset V$  that corresponds to some mincut, then the value of  $f(s, t)$  does not change for two nodes  $s, t \notin X$ .

We will show (later) that the connected components that we contract during a split-operation each correspond to some mincut and, hence,  $f_H(s, t) = f(s, t)$ , where  $f_H(s, t)$  is the value of a minimum  $s$ - $t$  mincut in graph  $H$ .

## Invariant [existence of representatives]:

For any edge  $\{S_i, S_j\}$  in  $T$ , there are vertices  $a \in S_i$  and  $b \in S_j$  such that  $w(S_i, S_j) = f(a, b)$  and the cut defined by edge  $\{S_i, S_j\}$  is a minimum  $a$ - $b$  cut in  $G$ .

## Analysis

We first show that the invariant implies that at the end of the algorithm  $T$  is indeed a cut-tree.

## Analysis

We first show that the invariant implies that at the end of the algorithm  $T$  is indeed a cut-tree.

- ▶ Let  $s = x_0, x_1, \dots, x_{k-1}, x_k = t$  be the unique simple path from  $s$  to  $t$  in the final tree  $T$ . From the invariant we get that  $f(x_i, x_{i+1}) = w(x_i, x_{i+1})$  for all  $j$ .

## Analysis

We first show that the invariant implies that at the end of the algorithm  $T$  is indeed a cut-tree.

- ▶ Let  $s = x_0, x_1, \dots, x_{k-1}, x_k = t$  be the unique simple path from  $s$  to  $t$  in the final tree  $T$ . From the invariant we get that  $f(x_i, x_{i+1}) = w(x_i, x_{i+1})$  for all  $j$ .
- ▶ Then

$$f_T(s, t)$$



## Analysis

We first show that the invariant implies that at the end of the algorithm  $T$  is indeed a cut-tree.

- ▶ Let  $s = x_0, x_1, \dots, x_{k-1}, x_k = t$  be the unique simple path from  $s$  to  $t$  in the final tree  $T$ . From the invariant we get that  $f(x_i, x_{i+1}) = w(x_i, x_{i+1})$  for all  $j$ .
- ▶ Then

$$f_T(s, t) = \min_{i \in \{0, \dots, k-1\}} \{w(x_i, x_{i+1})\}$$

## Analysis

We first show that the invariant implies that at the end of the algorithm  $T$  is indeed a cut-tree.

- ▶ Let  $s = x_0, x_1, \dots, x_{k-1}, x_k = t$  be the unique simple path from  $s$  to  $t$  in the final tree  $T$ . From the invariant we get that  $f(x_i, x_{i+1}) = w(x_i, x_{i+1})$  for all  $j$ .
- ▶ Then

$$\begin{aligned} f_T(s, t) &= \min_{i \in \{0, \dots, k-1\}} \{w(x_i, x_{i+1})\} \\ &= \min_{i \in \{0, \dots, k-1\}} \{f(x_i, x_{i+1})\} \end{aligned}$$

## Analysis

We first show that the invariant implies that at the end of the algorithm  $T$  is indeed a cut-tree.

- ▶ Let  $s = x_0, x_1, \dots, x_{k-1}, x_k = t$  be the unique simple path from  $s$  to  $t$  in the final tree  $T$ . From the invariant we get that  $f(x_i, x_{i+1}) = w(x_i, x_{i+1})$  for all  $j$ .
- ▶ Then

$$\begin{aligned} f_T(s, t) &= \min_{i \in \{0, \dots, k-1\}} \{w(x_i, x_{i+1})\} \\ &= \min_{i \in \{0, \dots, k-1\}} \{f(x_i, x_{i+1})\} \leq f(s, t) . \end{aligned}$$

## Analysis

We first show that the invariant implies that at the end of the algorithm  $T$  is indeed a cut-tree.

- ▶ Let  $s = x_0, x_1, \dots, x_{k-1}, x_k = t$  be the unique simple path from  $s$  to  $t$  in the final tree  $T$ . From the invariant we get that  $f(x_i, x_{i+1}) = w(x_i, x_{i+1})$  for all  $j$ .
- ▶ Then

$$\begin{aligned} f_T(s, t) &= \min_{i \in \{0, \dots, k-1\}} \{w(x_i, x_{i+1})\} \\ &= \min_{i \in \{0, \dots, k-1\}} \{f(x_i, x_{i+1})\} \leq f(s, t) . \end{aligned}$$

- ▶ Let  $\{x_j, x_{j+1}\}$  be the edge with minimum weight on the path.

## Analysis

We first show that the invariant implies that at the end of the algorithm  $T$  is indeed a cut-tree.

- ▶ Let  $s = x_0, x_1, \dots, x_{k-1}, x_k = t$  be the unique simple path from  $s$  to  $t$  in the final tree  $T$ . From the invariant we get that  $f(x_i, x_{i+1}) = w(x_i, x_{i+1})$  for all  $j$ .
- ▶ Then

$$\begin{aligned} f_T(s, t) &= \min_{i \in \{0, \dots, k-1\}} \{w(x_i, x_{i+1})\} \\ &= \min_{i \in \{0, \dots, k-1\}} \{f(x_i, x_{i+1})\} \leq f(s, t) . \end{aligned}$$

- ▶ Let  $\{x_j, x_{j+1}\}$  be the edge with minimum weight on the path.
- ▶ Since by the invariant this edge induces an  $s$ - $t$  cut with capacity  $f(x_j, x_{j+1})$  we get  $f(s, t) \leq f(x_j, x_{j+1}) = f_T(s, t)$ .

# Analysis

- ▶ Hence,  $f_T(s, t) = f(s, t)$  (flow equivalence).

# Analysis

- ▶ Hence,  $f_T(s, t) = f(s, t)$  (flow equivalence).
- ▶ The edge  $\{x_j, x_{j+1}\}$  is a mincut between  $s$  and  $t$  in  $T$ .

# Analysis

- ▶ Hence,  $f_T(s, t) = f(s, t)$  (flow equivalence).
- ▶ The edge  $\{x_j, x_{j+1}\}$  is a mincut between  $s$  and  $t$  in  $T$ .
- ▶ By invariant, it forms a cut with capacity  $f(x_j, x_{j+1})$  in  $G$  (which separates  $s$  and  $t$ ).



# Analysis

- ▶ Hence,  $f_T(s, t) = f(s, t)$  (flow equivalence).
- ▶ The edge  $\{x_j, x_{j+1}\}$  is a mincut between  $s$  and  $t$  in  $T$ .
- ▶ By invariant, it forms a cut with capacity  $f(x_j, x_{j+1})$  in  $G$  (which separates  $s$  and  $t$ ).
- ▶ Since, we can send a flow of value  $f(x_j, x_{j+1})$  btw.  $s$  and  $t$ , this is an  $s$ - $t$  mincut (cut property).

# Proof of Invariant

# Proof of Invariant

The invariant obviously holds at the beginning of the algorithm.

## Proof of Invariant

The invariant obviously holds at the beginning of the algorithm.

Now, we show that it holds after a split-operation provided that it was true before the operation.

## Proof of Invariant

The invariant obviously holds at the beginning of the algorithm.

Now, we show that it holds after a split-operation provided that it was true before the operation.

Let  $S_i$  denote our selected cluster with nodes  $a$  and  $b$ . Because of the invariant all edges leaving  $\{S_i\}$  in  $T$  correspond to some mincuts.

## Proof of Invariant

The invariant obviously holds at the beginning of the algorithm.

Now, we show that it holds after a split-operation provided that it was true before the operation.

Let  $S_i$  denote our selected cluster with nodes  $a$  and  $b$ . Because of the invariant all edges leaving  $\{S_i\}$  in  $T$  correspond to some mincuts.

Therefore, contracting the connected components does not change the mincut btw.  $a$  and  $b$  due to Lemma 8.

## Proof of Invariant

The invariant obviously holds at the beginning of the algorithm.

Now, we show that it holds after a split-operation provided that it was true before the operation.

Let  $S_i$  denote our selected cluster with nodes  $a$  and  $b$ . Because of the invariant all edges leaving  $\{S_i\}$  in  $T$  correspond to some mincuts.

Therefore, contracting the connected components does not change the mincut btw.  $a$  and  $b$  due to Lemma 8.

After the split we have to choose representatives for all edges. For the new edge  $\{S_i^a, S_i^b\}$  with capacity  $w(S_i^a, S_i^b) = f_H(a, b)$  we can simply choose  $a$  and  $b$  as representatives.

# Proof of Invariant



## Proof of Invariant

For edges that are not incident to  $S_i$  we do not need to change representatives as the neighbouring sets do not change.

## Proof of Invariant

For edges that are not incident to  $S_i$  we do not need to change representatives as the neighbouring sets do not change.

Consider an edge  $\{X, S_i\}$ , and suppose that before the split it used representatives  $x \in X$ , and  $s \in S_i$ . Assume that this edge is replaced by  $\{X, S_i^a\}$  in the new tree (the case when it is replaced by  $\{X, S_i^b\}$  is analogous).

## Proof of Invariant

For edges that are not incident to  $S_i$  we do not need to change representatives as the neighbouring sets do not change.

Consider an edge  $\{X, S_i\}$ , and suppose that before the split it used representatives  $x \in X$ , and  $s \in S_i$ . Assume that this edge is replaced by  $\{X, S_i^a\}$  in the new tree (the case when it is replaced by  $\{X, S_i^b\}$  is analogous).

If  $s \in S_i^a$  we can keep  $x$  and  $s$  as representatives.

## Proof of Invariant

For edges that are not incident to  $S_i$  we do not need to change representatives as the neighbouring sets do not change.

Consider an edge  $\{X, S_i\}$ , and suppose that before the split it used representatives  $x \in X$ , and  $s \in S_i$ . Assume that this edge is replaced by  $\{X, S_i^a\}$  in the new tree (the case when it is replaced by  $\{X, S_i^b\}$  is analogous).

If  $s \in S_i^a$  we can keep  $x$  and  $s$  as representatives.

Otherwise, we choose  $x$  and  $a$  as representatives. We need to show that  $f(x, a) = f(x, s)$ .

# Proof of Invariant

## Proof of Invariant

Because the invariant was true before the split we know that the edge  $\{X, S_i\}$  induces a cut in  $G$  of capacity  $f(x, s)$ . Since,  $x$  and  $a$  are on opposite sides of this cut, we know that  $f(x, a) \leq f(x, s)$ .

## Proof of Invariant

Because the invariant was true before the split we know that the edge  $\{X, S_i\}$  induces a cut in  $G$  of capacity  $f(x, s)$ . Since,  $x$  and  $a$  are on opposite sides of this cut, we know that  $f(x, a) \leq f(x, s)$ .

The set  $B$  forms a mincut separating  $a$  from  $b$ . Contracting all nodes in this set gives a new graph  $G'$  where the set  $B$  is represented by node  $v_B$ . Because of Lemma 8 we know that  $f'(x, a) = f(x, a)$  as  $x, a \notin B$ .

## Proof of Invariant

Because the invariant was true before the split we know that the edge  $\{X, S_i\}$  induces a cut in  $G$  of capacity  $f(x, s)$ . Since,  $x$  and  $a$  are on opposite sides of this cut, we know that  $f(x, a) \leq f(x, s)$ .

The set  $B$  forms a mincut separating  $a$  from  $b$ . Contracting all nodes in this set gives a new graph  $G'$  where the set  $B$  is represented by node  $v_B$ . Because of Lemma 8 we know that  $f'(x, a) = f(x, a)$  as  $x, a \notin B$ .

We further have  $f'(x, a) \geq \min\{f'(x, v_B), f'(v_B, a)\}$ .



## Proof of Invariant

Because the invariant was true before the split we know that the edge  $\{X, S_i\}$  induces a cut in  $G$  of capacity  $f(x, s)$ . Since,  $x$  and  $a$  are on opposite sides of this cut, we know that  $f(x, a) \leq f(x, s)$ .

The set  $B$  forms a mincut separating  $a$  from  $b$ . Contracting all nodes in this set gives a new graph  $G'$  where the set  $B$  is represented by node  $v_B$ . Because of Lemma 8 we know that  $f'(x, a) = f(x, a)$  as  $x, a \notin B$ .

We further have  $f'(x, a) \geq \min\{f'(x, v_B), f'(v_B, a)\}$ .

Since  $s \in B$  we have  $f'(v_B, x) \geq f(s, x)$ .

## Proof of Invariant

Because the invariant was true before the split we know that the edge  $\{X, S_i\}$  induces a cut in  $G$  of capacity  $f(x, s)$ . Since,  $x$  and  $a$  are on opposite sides of this cut, we know that  $f(x, a) \leq f(x, s)$ .

The set  $B$  forms a mincut separating  $a$  from  $b$ . Contracting all nodes in this set gives a new graph  $G'$  where the set  $B$  is represented by node  $v_B$ . Because of Lemma 8 we know that  $f'(x, a) = f(x, a)$  as  $x, a \notin B$ .

We further have  $f'(x, a) \geq \min\{f'(x, v_B), f'(v_B, a)\}$ .

Since  $s \in B$  we have  $f'(v_B, x) \geq f(s, x)$ .

Also,  $f'(a, v_B) \geq f(a, b) \geq f(x, s)$  since the  $a$ - $b$  cut that splits  $S_i$  into  $S_i^a$  and  $S_i^b$  also separates  $s$  and  $x$ .

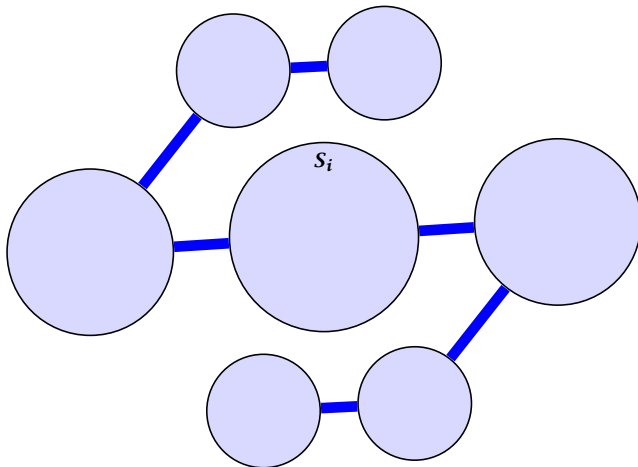

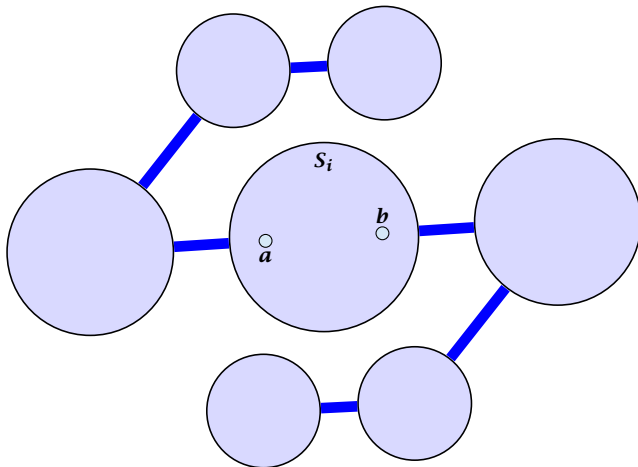

# Analysis

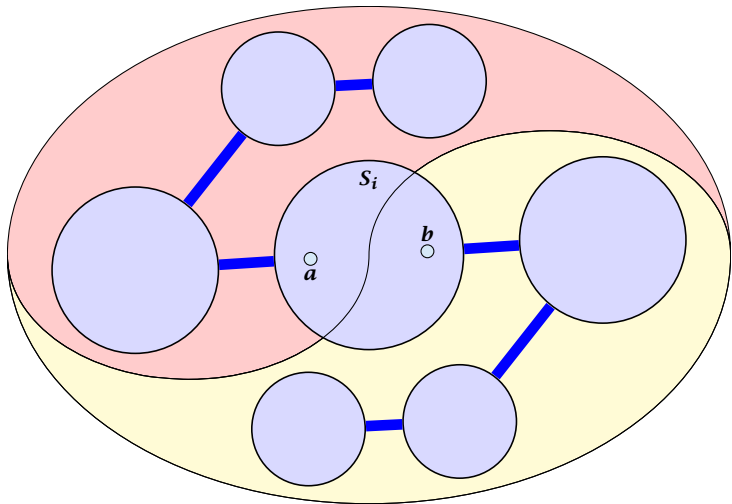

# Analysis

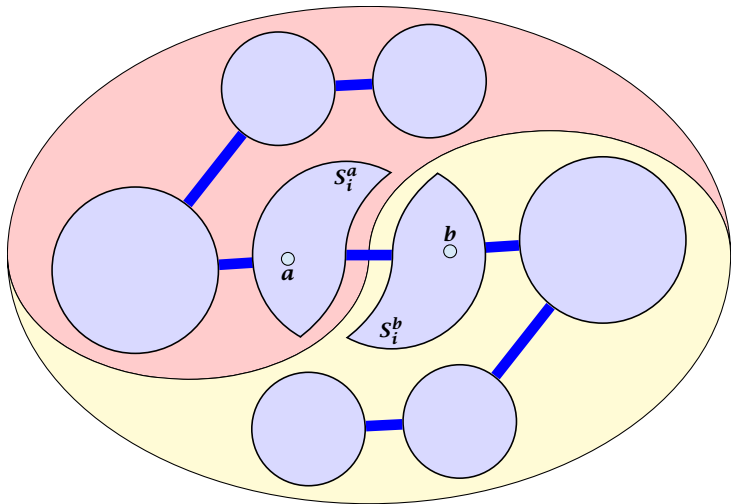

# Analysis

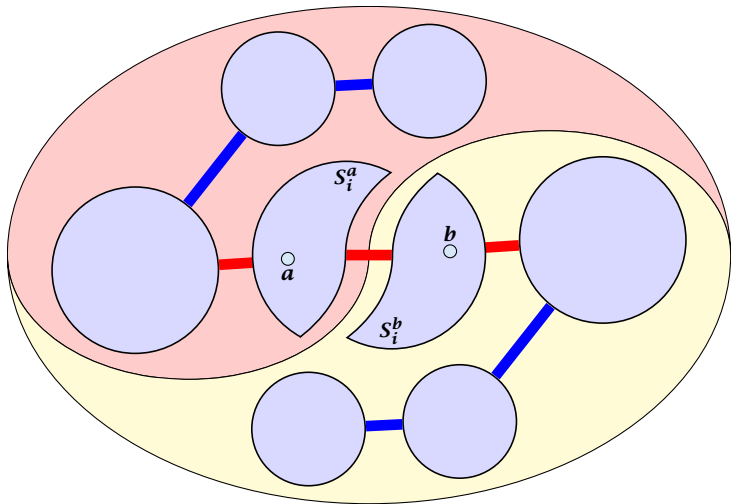

# Analysis

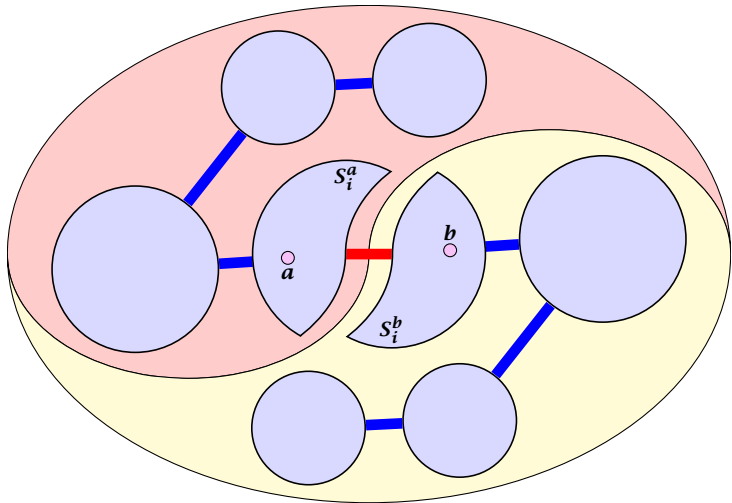



# Analysis

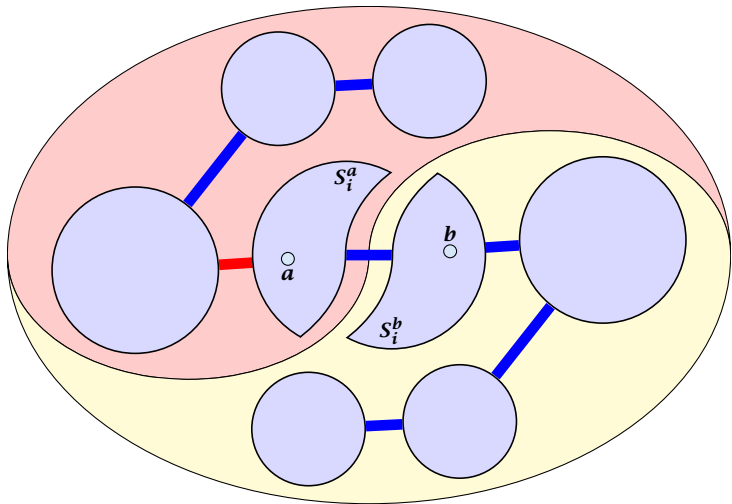

# Analysis

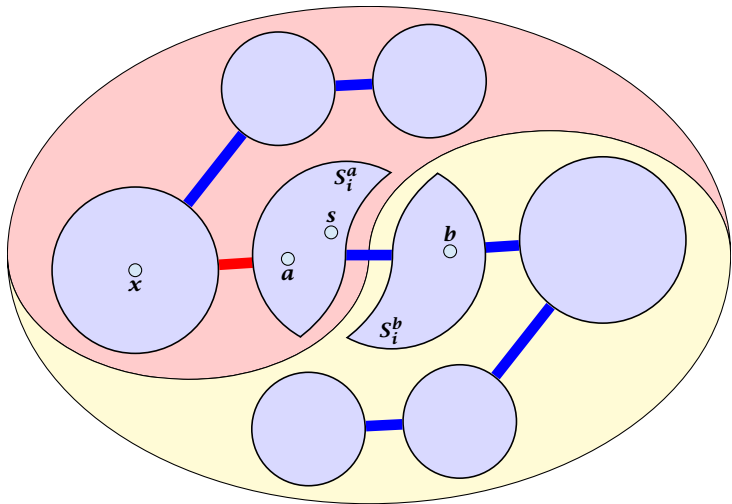

# Analysis

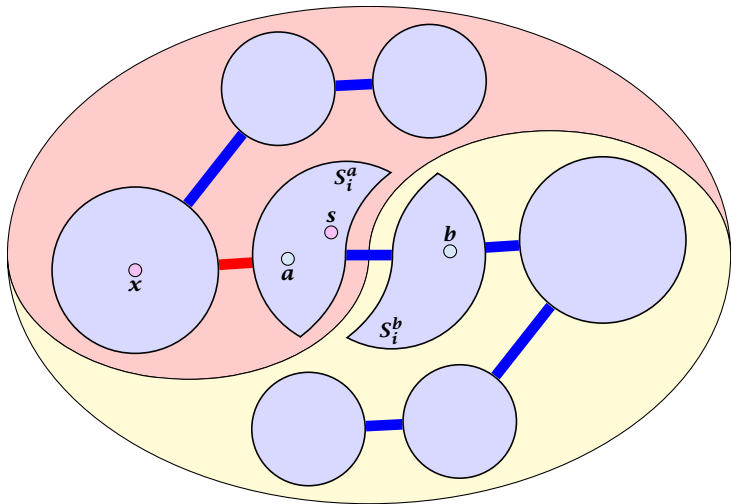

# Analysis

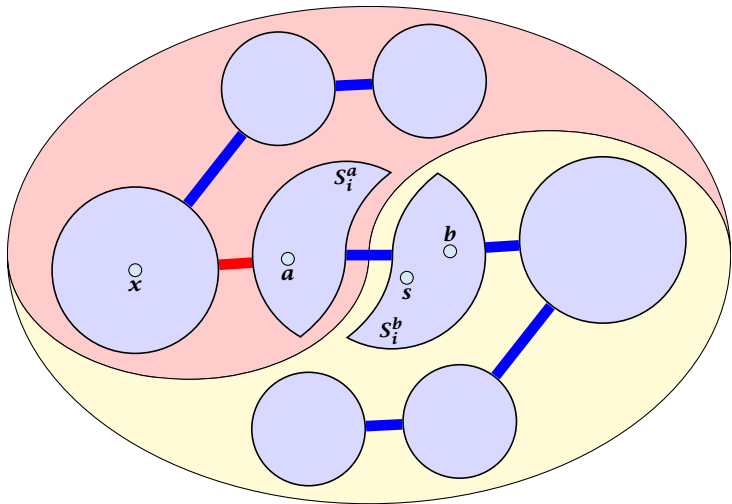

# Analysis

