

9 Union Find

Union Find Data Structure \mathcal{P} : Maintains a partition of **disjoint** sets over elements.

- ▶ **\mathcal{P} . makeset(x):** Given an element x , adds x to the data-structure and creates a singleton set that contains only this element. Returns a locator/handle for x in the data-structure.
- ▶ **\mathcal{P} . find(x):** Given a handle for an element x ; find the set that contains x . Returns a representative/identifier for this set.
- ▶ **\mathcal{P} . union(x, y):** Given two elements x , and y that are currently in sets S_x and S_y , respectively, the function replaces S_x and S_y by $S_x \cup S_y$ and returns an identifier for the new set.

9 Union Find

Applications:

- ▶ Keep track of the connected components of a dynamic graph that changes due to insertion of nodes and edges.
- ▶ Kruskals Minimum Spanning Tree Algorithm

9 Union Find

Algorithm 16 Kruskal-MST($G = (V, E), w$)

```
1:  $A \leftarrow \emptyset$ ;  
2: for all  $v \in V$  do  
3:    $v.\text{set} \leftarrow \mathcal{P}.\text{makeset}(v.\text{label})$   
4: sort edges in non-decreasing order of weight  $w$   
5: for all  $(u, v) \in E$  in non-decreasing order do  
6:   if  $\mathcal{P}.\text{find}(u.\text{set}) \neq \mathcal{P}.\text{find}(v.\text{set})$  then  
7:      $A \leftarrow A \cup \{(u, v)\}$   
8:      $\mathcal{P}.\text{union}(u.\text{set}, v.\text{set})$ 
```

List Implementation

- ▶ The elements of a set are stored in a list; each node has a backward pointer to the head.
- ▶ The head of the list contains the identifier for the set and a field that stores the **size** of the set.

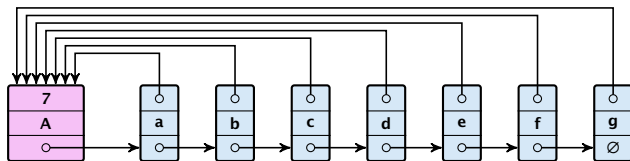

- ▶ **makeset**(x) can be performed in constant time.
- ▶ **find**(x) can be performed in constant time.

List Implementation

union(x, y)

- ▶ Determine sets S_x and S_y .
- ▶ Traverse the smaller list (say S_y), and change all backward pointers to the head of list S_x .
- ▶ Insert list S_y at the head of S_x .
- ▶ Adjust the size-field of list S_x .
- ▶ Time: $\min\{|S_x|, |S_y|\}$.

List Implementation

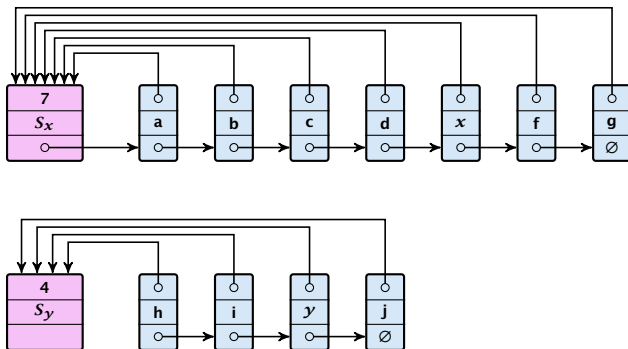

List Implementation

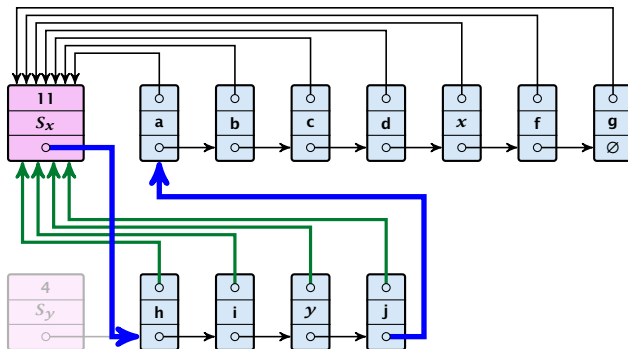

List Implementation

Running times:

- ▶ $\text{find}(x)$: constant
- ▶ $\text{makeset}(x)$: constant
- ▶ $\text{union}(x, y)$: $\mathcal{O}(n)$, where n denotes the number of elements contained in the set system.

List Implementation

Lemma 1

The list implementation for the ADT union find fulfills the following amortized time bounds:

- ▶ $\text{find}(x): \mathcal{O}(1)$.
- ▶ $\text{makeset}(x): \mathcal{O}(\log n)$.
- ▶ $\text{union}(x, y): \mathcal{O}(1)$.

The Accounting Method for Amortized Time Bounds

- ▶ There is a bank account for every element in the data structure.
- ▶ Initially the balance on all accounts is zero.
- ▶ Whenever for an operation the amortized time bound exceeds the actual cost, the difference is credited to some bank accounts of elements involved.
- ▶ Whenever for an operation the actual cost exceeds the amortized time bound, the difference is charged to bank accounts of some of the elements involved.
- ▶ If we can find a charging scheme that guarantees that balances always stay positive the amortized time bounds are proven.

List Implementation

- ▶ For an operation whose actual cost exceeds the amortized cost we charge the **excess** to the elements involved.
- ▶ In total we will charge at most $\mathcal{O}(\log n)$ to an element (regardless of the request sequence).
- ▶ For each element a makeset operation occurs as the first operation involving this element.
- ▶ We inflate the amortized cost of the makeset-operation to $\Theta(\log n)$, i.e., at this point we fill the bank account of the element to $\Theta(\log n)$.
- ▶ Later operations charge the account but the balance never drops below zero.

List Implementation

makeset(x): The actual cost is $\mathcal{O}(1)$. Due to the cost inflation the amortized cost is $\mathcal{O}(\log n)$.

find(x): For this operation we define the amortized cost and the actual cost to be the same. Hence, this operation does not change any accounts. Cost: $\mathcal{O}(1)$.

union(x, y):

- ▶ If $S_x = S_y$ the cost is constant; no bank accounts change.
- ▶ Otw. the actual cost is $\mathcal{O}(\min\{|S_x|, |S_y|\})$.
- ▶ Assume wlog. that S_x is the smaller set; let c denote the hidden constant, i.e., the actual cost is at most $c \cdot |S_x|$.
- ▶ Charge c to every element in set S_x .

List Implementation

Lemma 2

An element is charged at most $\lfloor \log_2 n \rfloor$ times, where n is the total number of elements in the set system.

Proof.

Whenever an element x is charged the number of elements in x 's set doubles. This can happen at most $\lfloor \log n \rfloor$ times. \square

Implementation via Trees

- ▶ Maintain nodes of a set in a tree.
- ▶ The root of the tree is the label of the set.
- ▶ Only pointer to parent exists; we cannot list all elements of a given set.
- ▶ Example:

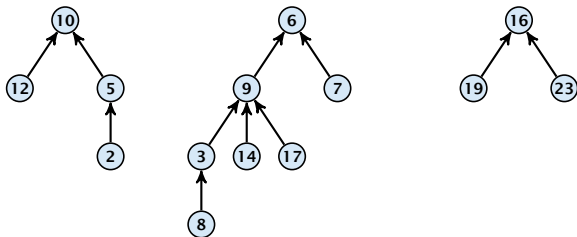

Set system $\{2, 5, 10, 12\}$, $\{3, 6, 7, 8, 9, 14, 17\}$, $\{16, 19, 23\}$.

Implementation via Trees

makeiset(x)

- ▶ Create a singleton tree. Return pointer to the root.
- ▶ Time: $\mathcal{O}(1)$.

find(x)

- ▶ Start at element x in the tree. Go upwards until you reach the root.
- ▶ Time: $\mathcal{O}(\text{level}(x))$, where $\text{level}(x)$ is the distance of element x to the root in its tree. **Not constant.**

Implementation via Trees

To support union we store the size of a tree in its root.

union(x, y)

- ▶ Perform $a \leftarrow \text{find}(x)$; $b \leftarrow \text{find}(y)$. Then: $\text{link}(a, b)$.
- ▶ $\text{link}(a, b)$ attaches the **smaller** tree as the child of the larger.
- ▶ In addition it updates the size-field of the new root.

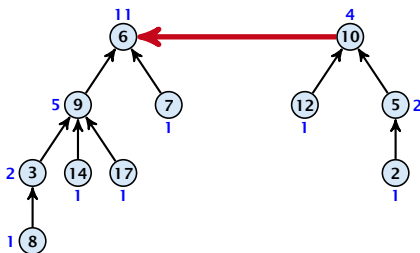

- ▶ Time: constant for $\text{link}(a, b)$ plus two find-operations.

Implementation via Trees

Lemma 3

The running time (non-amortized!!!) for $\text{find}(x)$ is $\mathcal{O}(\log n)$.

Proof.

- ▶ When we attach a tree with root c to become a child of a tree with root p , then $\text{size}(p) \geq 2 \text{size}(c)$, where size denotes the value of the size-field right after the operation.
- ▶ After that the value of $\text{size}(c)$ stays fixed, while the value of $\text{size}(p)$ may still increase.
- ▶ Hence, at any point in time a tree fulfills $\text{size}(p) \geq 2 \text{size}(c)$, for any pair of nodes (p, c) , where p is a parent of c .



Path Compression

find(x):

- ▶ Go upward until you find the root.
- ▶ Re-attach all visited nodes as children of the root.
- ▶ Speeds up successive find-operations.

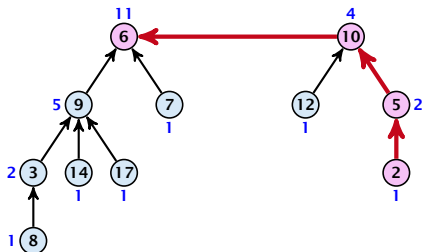

- ▶ Note that the size-fields now only give an upper bound on the size of a sub-tree.

Path Compression

find(x):

- ▶ Go upward until you find the root.
- ▶ Re-attach all visited nodes as children of the root.
- ▶ Speeds up successive find-operations.

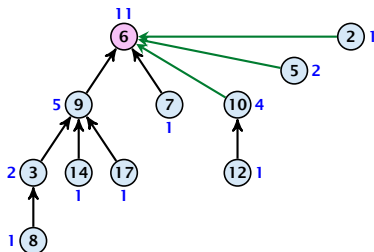

One could change the algorithm to update the size-fields. This could be done without asymptotically affecting the running time.

However, the only size-field that is actually required is the field at the root, which is always correct.

We will only use the other size-fields for the proof of Theorem 6.

- ▶ Note that the size-fields now only give an upper bound on the size of a sub-tree.

Path Compression

Asymptotically the cost for a find-operation does not increase due to the path compression heuristic.

However, for a worst-case analysis there is no improvement on the running time. It can still happen that a find-operation takes time $\mathcal{O}(\log n)$.

Amortized Analysis

Definitions:

- ▶ $\text{size}(v) :=$ the number of nodes that were in the sub-tree rooted at v when v became the child of another node (or the number of nodes if v is the root).

Note that this is the same as the size of v 's subtree in the case that there are no find-operations.

- ▶ $\text{rank}(v) := \lfloor \log(\text{size}(v)) \rfloor$.
- ▶ $\Rightarrow \text{size}(v) \geq 2^{\text{rank}(v)}$.

Lemma 4

The rank of a parent must be strictly larger than the rank of a child.

Amortized Analysis

Lemma 5

There are at most $n/2^s$ nodes of rank s .

Proof.

- ▶ Let's say a node v sees node x if v is in x 's sub-tree at the time that x becomes a child.
- ▶ A node v sees at most one node of rank s during the running time of the algorithm.
- ▶ This holds because the rank-sequence of the roots of the different trees that contain v during the running time of the algorithm is a strictly increasing sequence.
- ▶ Hence, every node sees at most one rank s node, but every rank s node is seen by at least 2^s different nodes. □

Amortized Analysis

We define

$$\text{tow}(i) := \begin{cases} 1 & \text{if } i = 0 \\ 2^{\text{tow}(i-1)} & \text{otw.} \end{cases} \quad \text{tow}(i) = 2^{2^{2^{2^{2^2}}}} \text{ } i \text{ times}$$

and

$$\log^*(n) := \min\{i \mid \text{tow}(i) \geq n\} .$$

Theorem 6

Union find with path compression fulfills the following amortized running times:

- ▶ $\text{makeset}(x) : \mathcal{O}(\log^*(n))$
- ▶ $\text{find}(x) : \mathcal{O}(\log^*(n))$
- ▶ $\text{union}(x, y) : \mathcal{O}(\log^*(n))$

Amortized Analysis

In the following we assume $n \geq 2$.

rank-group:

- ▶ A node with rank $\text{rank}(v)$ is in **rank group** $\log^*(\text{rank}(v))$.
- ▶ The rank-group $g = 0$ contains only nodes with rank 0 or rank 1.
- ▶ A rank group $g \geq 1$ contains ranks $\text{tow}(g-1) + 1, \dots, \text{tow}(g)$.
- ▶ The maximum non-empty rank group is $\log^*(\lfloor \log n \rfloor) \leq \log^*(n) - 1$ (which holds for $n \geq 2$).
- ▶ Hence, the total number of rank-groups is at most $\log^* n$.

Amortized Analysis

Accounting Scheme:

- ▶ create an account for every find-operation
- ▶ create an account for every node v

The cost for a find-operation is equal to the length of the path traversed. We charge the cost for going from v to $\text{parent}[v]$ as follows:

- ▶ If $\text{parent}[v]$ is the root we charge the cost to the find-account.
- ▶ If the group-number of $\text{rank}(v)$ is the same as that of $\text{rank}(\text{parent}[v])$ (before starting path compression) we charge the cost to the node-account of v .
- ▶ Otherwise we charge the cost to the find-account.

Amortized Analysis

Observations:

- ▶ A find-account is charged at most $\log^*(n)$ times (once for the root and at most $\log^*(n) - 1$ times when increasing the rank-group).
- ▶ After a node v is charged its parent-edge is re-assigned. The rank of the parent strictly increases.
- ▶ After some charges to v the parent will be in a larger rank-group. $\Rightarrow v$ will **never** be charged again.
- ▶ The total charge made to a node in rank-group g is at most $\text{tow}(g) - \text{tow}(g - 1) - 1 \leq \text{tow}(g)$.

Amortized Analysis

What is the total charge made to nodes?

- ▶ The total charge is at most

$$\sum_g n(g) \cdot \text{tow}(g) ,$$

where $n(g)$ is the number of nodes in group g .

Amortized Analysis

For $g \geq 1$ we have

$$\begin{aligned}n(g) &\leq \sum_{s=\text{tow}(g-1)+1}^{\text{tow}(g)} \frac{n}{2^s} \leq \sum_{s=\text{tow}(g-1)+1}^{\infty} \frac{n}{2^s} \\&= \frac{n}{2^{\text{tow}(g-1)+1}} \sum_{s=0}^{\infty} \frac{1}{2^s} = \frac{n}{2^{\text{tow}(g-1)+1}} \cdot 2 \\&= \frac{n}{2^{\text{tow}(g)}} = \frac{n}{\text{tow}(g)} .\end{aligned}$$

Hence,

$$\sum_g n(g) \text{tow}(g) \leq n(0) \text{tow}(0) + \sum_{g \geq 1} n(g) \text{tow}(g) \leq n \log^*(n)$$

Amortized Analysis

Without loss of generality we can assume that all **makeset**-operations occur at the start.

This means if we inflate the cost of **makeset** to $\log^* n$ and add this to the node account of v then the balances of all node accounts will sum up to a positive value (this is sufficient to obtain an amortized bound).

Amortized Analysis

The analysis is not tight. In fact it has been shown that the amortized time for the union-find data structure with path compression is $\mathcal{O}(\alpha(m, n))$, where $\alpha(m, n)$ is the inverse Ackermann function which grows a lot lot slower than $\log^* n$. (Here, we consider the average running time of m operations on at most n elements).

There is also a lower bound of $\Omega(\alpha(m, n))$.

Amortized Analysis

$$A(x, y) = \begin{cases} y + 1 & \text{if } x = 0 \\ A(x - 1, 1) & \text{if } y = 0 \\ A(x - 1, A(x, y - 1)) & \text{otw.} \end{cases}$$

$$\alpha(m, n) = \min\{i \geq 1 : A(i, \lfloor m/n \rfloor) \geq \log n\}$$

- ▶ $A(0, y) = y + 1$
- ▶ $A(1, y) = y + 2$
- ▶ $A(2, y) = 2y + 3$
- ▶ $A(3, y) = 2^{y+3} - 3$
- ▶ $A(4, y) = \underbrace{2^{2^{2^2}}}_{y+3 \text{ times}} - 3$

Bibliography

- [CLRS90a] Thomas H. Cormen, Charles E. Leiserson, Ron L. Rivest:
Introduction to Algorithms (1st ed.),
MIT Press and McGraw-Hill, 1990
- [CLRS90b] Thomas H. Cormen, Charles E. Leiserson, Ron L. Rivest, Clifford Stein:
Introduction to Algorithms (2nd ed.),
MIT Press and McGraw-Hill, 2001
- [CLRS90c] Thomas H. Cormen, Charles E. Leiserson, Ron L. Rivest, Clifford Stein:
Introduction to Algorithms (3rd ed.),
MIT Press and McGraw-Hill, 2009
- [AHU74] Alfred V. Aho, John E. Hopcroft, Jeffrey D. Ullman:
The Design and Analysis of Computer Algorithms,
Addison-Wesley, 1974

Union find data structures are discussed in Chapter 21 of [CLRS90b] and [CLRS90c] and in Chapter 22 of [CLRS90a]. The analysis of union by rank with path compression can be found in [CLRS90a] but neither in [CLRS90b] nor in [CLRS90c]. The latter books contain a more involved analysis that gives a better bound than $\mathcal{O}(\log^* n)$.

A description of the $\mathcal{O}(\log^*)$ -bound can also be found in Chapter 4.8 of [AHU74].