

Part III

Approximation Algorithms

There are many practically important optimization problems that are NP-hard.

What can we do?

- ▶ Heuristics.
- ▶ Exploit special structure of instances occurring in practise.
- ▶ Consider algorithms that do not compute the optimal solution but provide solutions that are close to optimum.

Definition 2

An α -approximation for an optimization problem is a polynomial-time algorithm that for all instances of the problem produces a solution whose value is within a factor of α of the value of an optimal solution.

Why approximation algorithms?

- ▶ We need algorithms for hard problems.
- ▶ It gives a rigorous mathematical base for studying heuristics.
- ▶ It provides a metric to compare the difficulty of various optimization problems.
- ▶ Proving theorems may give a deeper theoretical understanding which in turn leads to new algorithmic approaches.

Why not?

- ▶ Sometimes the results are very pessimistic due to the fact that an algorithm has to provide a close-to-optimum solution on every instance.

Definition 3

An optimization problem $P = (\mathcal{I}, \text{sol}, m, \text{goal})$ is in **NPO** if

- ▶ $x \in \mathcal{I}$ can be **decided** in polynomial time
- ▶ $y \in \text{sol}(\mathcal{I})$ can be **verified** in polynomial time
- ▶ m can be computed in polynomial time
- ▶ $\text{goal} \in \{\text{min}, \text{max}\}$

In other words: the decision problem **is there a solution y with $m(x, y)$ at most/at least z** is in NP.

- ▶ x is problem instance
- ▶ y is candidate solution
- ▶ $m^*(x)$ cost/profit of an optimal solution

Definition 4 (Performance Ratio)

$$R(x, y) := \max \left\{ \frac{m(x, y)}{m^*(x)}, \frac{m^*(x)}{m(x, y)} \right\}$$

Definition 5 (r -approximation)

An algorithm A is an r -approximation algorithm iff

$$\forall x \in \mathcal{I} : R(x, A(x)) \leq r ,$$

and A runs in polynomial time.

Definition 6 (PTAS)

A PTAS for a problem P from NPO is an algorithm that takes as input $x \in \mathcal{I}$ and $\epsilon > 0$ and produces a solution y for x with

$$R(x, y) \leq 1 + \epsilon .$$

The running time is polynomial in $|x|$.

approximation with arbitrary good factor... fast?

Problems that have a PTAS

Scheduling. Given m jobs with known processing times; schedule the jobs on n machines such that the MAKESPAN is minimized.

Definition 7 (FPTAS)

An FPTAS for a problem P from NPO is an algorithm that takes as input $x \in \mathcal{I}$ and $\epsilon > 0$ and produces a solution y for x with

$$R(x, y) \leq 1 + \epsilon .$$

The running time is polynomial in $|x|$ and $1/\epsilon$.

approximation with arbitrary good factor... fast!

Problems that have an FPTAS

KNAPSACK. Given a set of items with profits and weights choose a subset of total weight at most W s.t. the profit is maximized.

Definition 8 (APX – approximable)

A problem P from NPO is in APX if there exist a constant $r \geq 1$ and an r -approximation algorithm for P .

constant factor approximation...

Problems that are in APX

MAXCUT. Given a graph $G = (V, E)$; partition V into two disjoint pieces A and B s. t. the number of edges between both pieces is maximized.

MAX-3SAT. Given a 3CNF-formula. Find an assignment to the variables that satisfies the maximum number of clauses.

Problems with polylogarithmic approximation guarantees

- ▶ Set Cover
- ▶ Minimum Multicut
- ▶ Sparsest Cut
- ▶ Minimum Bisection

There is an r -approximation with $r \leq \mathcal{O}(\log^c(|x|))$ for some constant c .

Note that only for some of the above problem a matching lower bound is known.

There are really difficult problems!

Theorem 9

For any constant $\epsilon > 0$ there does not exist an $\Omega(n^{1-\epsilon})$ -approximation algorithm for the maximum clique problem on a given graph G with n nodes unless $P = NP$.

Note that an n -approximation is trivial.

There are weird problems!

Asymmetric k -Center admits an $\mathcal{O}(\log^* n)$ -approximation.

There is no $o(\log^* n)$ -approximation to Asymmetric k -Center unless $NP \subseteq DTIME(n^{\log \log \log n})$.

Class APX not important in practise.

Instead of saying **problem P is in APX** one says **problem P admits a 4-approximation.**

One only says that a problem is **APX-hard.**

A crucial ingredient for the design and analysis of approximation algorithms is a technique to obtain an upper bound (for maximization problems) or a lower bound (for minimization problems).

Therefore **Linear Programs** or **Integer Linear Programs** play a vital role in the design of many approximation algorithms.

Definition 10

An **Integer Linear Program** or **Integer Program** is a Linear Program in which all variables are required to be integral.

Definition 11

A **Mixed Integer Program** is a Linear Program in which a subset of the variables are required to be integral.

Many important combinatorial optimization problems can be formulated in the form of an Integer Program.

Note that solving Integer Programs in general is NP-complete!

Set Cover

Given a ground set U , a collection of subsets $S_1, \dots, S_k \subseteq U$, where the i -th subset S_i has weight/cost w_i . Find a collection $I \subseteq \{1, \dots, k\}$ such that

$$\forall u \in U \exists i \in I: u \in S_i \text{ (every element is covered)}$$

and

$$\sum_{i \in I} w_i \text{ is minimized.}$$

Set Cover

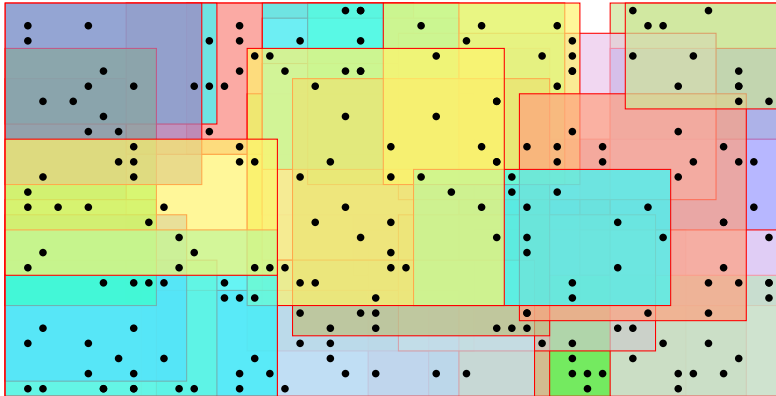

IP-Formulation of Set Cover

$$\begin{array}{llll} \min & & \sum_i w_i x_i & \\ \text{s.t.} & \forall u \in U & \sum_{i:u \in S_i} x_i & \geq 1 \\ & \forall i \in \{1, \dots, k\} & x_i & \geq 0 \\ & \forall i \in \{1, \dots, k\} & x_i & \text{integral} \end{array}$$

Vertex Cover

Given a graph $G = (V, E)$ and a weight w_v for every node. Find a vertex subset $S \subseteq V$ of minimum weight such that every edge is incident to at least one vertex in S .

IP-Formulation of Vertex Cover

$$\begin{array}{ll} \min & \sum_{v \in V} w_v x_v \\ \text{s.t.} & \forall e = (i, j) \in E \quad x_i + x_j \geq 1 \\ & \forall v \in V \quad x_v \in \{0, 1\} \end{array}$$

Maximum Weighted Matching

Given a graph $G = (V, E)$, and a weight w_e for every edge $e \in E$. Find a subset of edges of maximum weight such that no vertex is incident to more than one edge.

$$\begin{array}{ll} \max & \sum_{e \in E} w_e x_e \\ \text{s.t.} & \forall v \in V \quad \sum_{e: v \in e} x_e \leq 1 \\ & \forall e \in E \quad x_e \in \{0, 1\} \end{array}$$

Maximum Independent Set

Given a graph $G = (V, E)$, and a weight w_v for every node $v \in V$. Find a subset $S \subseteq V$ of nodes of maximum weight such that no two vertices in S are adjacent.

$$\begin{array}{ll} \max & \sum_{v \in V} w_v x_v \\ \text{s.t.} & \forall e = (i, j) \in E \quad x_i + x_j \leq 1 \\ & \forall v \in V \quad x_v \in \{0, 1\} \end{array}$$

Knapsack

Given a set of items $\{1, \dots, n\}$, where the i -th item has weight w_i and profit p_i , and given a threshold K . Find a subset $I \subseteq \{1, \dots, n\}$ of items of total weight at most K such that the profit is maximized.

$$\begin{array}{ll} \max & \sum_{i=1}^n p_i x_i \\ \text{s.t.} & \sum_{i=1}^n w_i x_i \leq K \\ & \forall i \in \{1, \dots, n\} \quad x_i \in \{0, 1\} \end{array}$$

Definition 12

A linear program LP is a **relaxation** of an integer program IP if any feasible solution for IP is also feasible for LP and if the objective values of these solutions are identical in both programs.

We obtain a relaxation for all examples by writing $x_i \in [0, 1]$ instead of $x_i \in \{0, 1\}$.

By solving a relaxation we obtain an upper bound for a maximization problem and a lower bound for a minimization problem.

Relations

Maximization Problems:

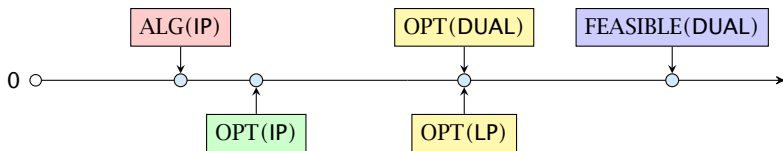

Minimization Problems:

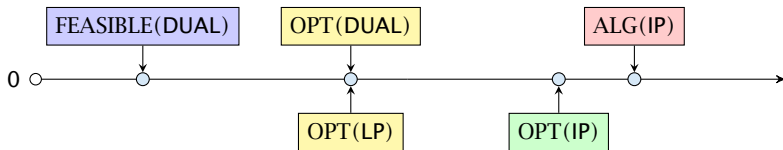

Technique 1: Round the LP solution.

We first solve the LP-relaxation and then we round the fractional values so that we obtain an integral solution.

Set Cover relaxation:

$$\begin{array}{ll} \min & \sum_{i=1}^k w_i x_i \\ \text{s.t.} & \forall u \in U \quad \sum_{i:u \in S_i} x_i \geq 1 \\ & \forall i \in \{1, \dots, k\} \quad x_i \in [0, 1] \end{array}$$

Let f_u be the number of sets that the element u is contained in (the frequency of u). Let $f = \max_u \{f_u\}$ be the maximum frequency.

Technique 1: Round the LP solution.

Rounding Algorithm:

Set all x_i -values with $x_i \geq \frac{1}{f}$ to 1. Set all other x_i -values to 0.

Technique 1: Round the LP solution.

Lemma 13

The rounding algorithm gives an f -approximation.

Proof: Every $u \in U$ is covered.

- ▶ We know that $\sum_{i:u \in S_i} x_i \geq 1$.
- ▶ The sum contains at most $f_u \leq f$ elements.
- ▶ Therefore one of the sets that contain u must have $x_i \geq 1/f$.
- ▶ This set will be selected. Hence, u is covered.

Technique 1: Round the LP solution.

The cost of the rounded solution is at most $f \cdot \text{OPT}$.

$$\begin{aligned}\sum_{i \in I} w_i &\leq \sum_{i=1}^k w_i (f \cdot x_i) \\ &= f \cdot \text{cost}(x) \\ &\leq f \cdot \text{OPT} .\end{aligned}$$

Technique 2: Rounding the Dual Solution.

Relaxation for Set Cover

Primal:

$$\begin{array}{ll} \min & \sum_{i \in I} w_i x_i \\ \text{s.t. } \forall u & \sum_{i: u \in S_i} x_i \geq 1 \\ & x_i \geq 0 \end{array}$$

Dual:

$$\begin{array}{ll} \max & \sum_{u \in U} y_u \\ \text{s.t. } \forall i & \sum_{u: u \in S_i} y_u \leq w_i \\ & y_u \geq 0 \end{array}$$

Technique 2: Rounding the Dual Solution.

Rounding Algorithm:

Let I denote the index set of sets for which the dual constraint is tight. This means for all $i \in I$

$$\sum_{u:u \in S_i} y_u = w_i$$

Technique 2: Rounding the Dual Solution.

Lemma 14

The resulting index set is an f -approximation.

Proof:

Every $u \in U$ is covered.

- ▶ Suppose there is a u that is not covered.
- ▶ This means $\sum_{u:u \in S_i} y_u < w_i$ for all sets S_i that contain u .
- ▶ But then y_u could be increased in the dual solution without violating any constraint. This is a contradiction to the fact that the dual solution is optimal.

Technique 2: Rounding the Dual Solution.

Proof:

$$\begin{aligned}\sum_{i \in I} w_i &= \sum_{i \in I} \sum_{u: u \in S_i} y_u \\ &= \sum_u |\{i \in I : u \in S_i\}| \cdot y_u \\ &\leq \sum_u f_u y_u \\ &\leq f \sum_u y_u \\ &\leq f \text{cost}(x^*) \\ &\leq f \cdot \text{OPT}\end{aligned}$$

Let I denote the solution obtained by the first rounding algorithm and I' be the solution returned by the second algorithm. Then

$$I \subseteq I' .$$

This means I' is never better than I .

- ▶ Suppose that we take S_i in the first algorithm. I.e., $i \in I$.
- ▶ This means $x_i \geq \frac{1}{f}$.
- ▶ Because of **Complementary Slackness Conditions** the corresponding constraint in the dual must be tight.
- ▶ Hence, the second algorithm will also choose S_i .

Technique 3: The Primal Dual Method

The previous two rounding algorithms have the disadvantage that it is necessary to solve the LP. The following method also gives an f -approximation without solving the LP.

For estimating the cost of the solution we only required two properties.

1. The solution is dual feasible and, hence,

$$\sum_u y_u \leq \text{cost}(x^*) \leq \text{OPT}$$

where x^* is an optimum solution to the primal LP.

2. The set I contains only sets for which the dual inequality is tight.

Of course, we also need that I is a cover.

Technique 3: The Primal Dual Method

Algorithm 1 PrimalDual

- 1: $y \leftarrow 0$
- 2: $I \leftarrow \emptyset$
- 3: **while** exists $u \notin \bigcup_{i \in I} S_i$ **do**
- 4: increase dual variable y_u until constraint for some
 new set S_ℓ becomes tight
- 5: $I \leftarrow I \cup \{\ell\}$

Technique 4: The Greedy Algorithm

Algorithm 1 Greedy

- 1: $I \leftarrow \emptyset$
- 2: $\hat{S}_j \leftarrow S_j$ for all j
- 3: **while** I not a set cover **do**
- 4: $\ell \leftarrow \arg \min_{j: \hat{S}_j \neq \emptyset} \frac{w_j}{|\hat{S}_j|}$
- 5: $I \leftarrow I \cup \{\ell\}$
- 6: $\hat{S}_j \leftarrow \hat{S}_j - S_\ell$ for all j

In every round the Greedy algorithm takes the set that covers remaining elements in the most **cost-effective** way.

We choose a set such that the ratio between cost and still uncovered elements in the set is minimized.

Technique 4: The Greedy Algorithm

Lemma 15

Given positive numbers a_1, \dots, a_k and b_1, \dots, b_k , and $S \subseteq \{1, \dots, k\}$ then

$$\min_i \frac{a_i}{b_i} \leq \frac{\sum_{i \in S} a_i}{\sum_{i \in S} b_i} \leq \max_i \frac{a_i}{b_i}$$

Technique 4: The Greedy Algorithm

Let n_ℓ denote the number of elements that remain at the beginning of iteration ℓ . $n_1 = n = |U|$ and $n_{s+1} = 0$ if we need s iterations.

In the ℓ -th iteration

$$\min_j \frac{w_j}{|\hat{S}_j|} \leq \frac{\sum_{j \in \text{OPT}} w_j}{\sum_{j \in \text{OPT}} |\hat{S}_j|} = \frac{\text{OPT}}{\sum_{j \in \text{OPT}} |\hat{S}_j|} \leq \frac{\text{OPT}}{n_\ell}$$

since an optimal algorithm can cover the remaining n_ℓ elements with cost OPT .

Let \hat{S}_j be a subset that minimizes this ratio. Hence,
 $w_j / |\hat{S}_j| \leq \frac{\text{OPT}}{n_\ell}$.

Technique 4: The Greedy Algorithm

Adding this set to our solution means $n_{\ell+1} = n_{\ell} - |\hat{S}_j|$.

$$w_j \leq \frac{|\hat{S}_j| \text{OPT}}{n_{\ell}} = \frac{n_{\ell} - n_{\ell+1}}{n_{\ell}} \cdot \text{OPT}$$

Technique 4: The Greedy Algorithm

$$\begin{aligned}\sum_{j \in I} w_j &\leq \sum_{\ell=1}^s \frac{n_\ell - n_{\ell+1}}{n_\ell} \cdot \text{OPT} \\ &\leq \text{OPT} \sum_{\ell=1}^s \left(\frac{1}{n_\ell} + \frac{1}{n_\ell - 1} + \dots + \frac{1}{n_{\ell+1} + 1} \right) \\ &= \text{OPT} \sum_{i=1}^k \frac{1}{i} \\ &= H_n \cdot \text{OPT} \leq \text{OPT}(\ln n + 1) .\end{aligned}$$

Technique 4: The Greedy Algorithm

A tight example:

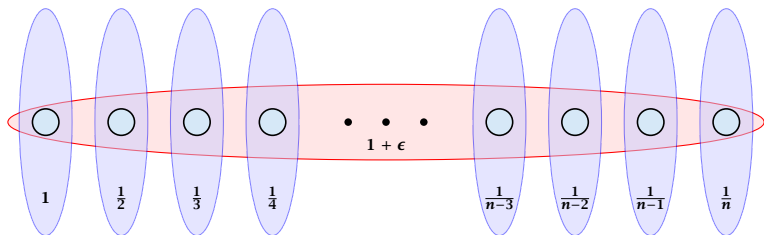

Technique 5: Randomized Rounding

One round of randomized rounding:

Pick set S_j uniformly at random with probability $1 - x_j$ (for all j).

Version A: Repeat rounds until you nearly have a cover. Cover remaining elements by some simple heuristic.

Version B: Repeat for s rounds. If you have a cover STOP. Otherwise, repeat the whole algorithm.

Probability that $u \in U$ is not covered (in one round):

$$\begin{aligned}\Pr[u \text{ not covered in one round}] &= \prod_{j:u \in S_j} (1 - x_j) \leq \prod_{j:u \in S_j} e^{-x_j} \\ &= e^{-\sum_{j:u \in S_j} x_j} \leq e^{-1} .\end{aligned}$$

Probability that $u \in U$ is not covered (after ℓ rounds):

$$\Pr[u \text{ not covered after } \ell \text{ round}] \leq \frac{1}{e^\ell} .$$

$$\begin{aligned} & \Pr[\exists u \in U \text{ not covered after } \ell \text{ round}] \\ &= \Pr[u_1 \text{ not covered} \vee u_2 \text{ not covered} \vee \dots \vee u_n \text{ not covered}] \\ &\leq \sum_i \Pr[u_i \text{ not covered after } \ell \text{ rounds}] \leq ne^{-\ell} . \end{aligned}$$

Lemma 16

With high probability $\mathcal{O}(\log n)$ rounds suffice.

With high probability:

For any constant α the number of rounds is at most $\mathcal{O}(\log n)$ with probability at least $1 - n^{-\alpha}$.

Proof: We have

$$\Pr[\text{\#rounds} \geq (\alpha + 1) \ln n] \leq ne^{-(\alpha+1)\ln n} = n^{-\alpha} .$$

Expected Cost

- ▶ Version A.

Repeat for $s = (\alpha + 1) \ln n$ rounds. If you don't have a cover simply take for each element u the cheapest set that contains u .

$$E[\text{cost}] \leq (\alpha + 1) \ln n \cdot \text{cost}(LP) + (n \cdot \text{OPT}) n^{-\alpha} = \mathcal{O}(\ln n) \cdot \text{OPT}$$

Expected Cost

► Version B.

Repeat for $s = (\alpha + 1) \ln n$ rounds. If you don't have a cover simply repeat the whole process.

$$E[\text{cost}] = \Pr[\text{success}] \cdot E[\text{cost} \mid \text{success}] \\ + \Pr[\text{no success}] \cdot E[\text{cost} \mid \text{no success}]$$

This means

$$E[\text{cost} \mid \text{success}] \\ = \frac{1}{\Pr[\text{succ.}]} \left(E[\text{cost}] - \Pr[\text{no success}] \cdot E[\text{cost} \mid \text{no success}] \right) \\ \leq \frac{1}{\Pr[\text{succ.}]} E[\text{cost}] \leq \frac{1}{1 - n^{-\alpha}} (\alpha + 1) \ln n \cdot \text{cost}(\text{LP}) \\ \leq 2(\alpha + 1) \ln n \cdot \text{OPT}$$

for $n \geq 2$ and $\alpha \geq 1$.

Randomized rounding gives an $\mathcal{O}(\log n)$ approximation. The running time is polynomial with high probability.

Theorem 17 (without proof)

There is no approximation algorithm for set cover with approximation guarantee better than $\frac{1}{2} \log n$ unless NP has quasi-polynomial time algorithms (algorithms with running time $2^{\text{poly}(\log n)}$).

Integrality Gap

The **integrality gap** of the SetCover LP is $\Omega(\log n)$.

- ▶ $n = 2^k - 1$
- ▶ Elements are all vectors \vec{x} over $GF[2]$ of length k (excluding zero vector).
- ▶ Every vector \vec{y} defines a set as follows

$$S_{\vec{y}} := \{\vec{x} \mid \vec{x}^T \vec{y} = 1\}$$

- ▶ each set contains 2^{k-1} vectors; each vector is contained in 2^{k-1} sets
- ▶ $x_i = \frac{1}{2^{k-1}} = \frac{2}{n+1}$ is fractional solution.

Integrality Gap

Every collection of $p < k$ sets does not cover all elements.

Hence, we get a gap of $\Omega(\log n)$.

Techniques:

- ▶ Deterministic Rounding
- ▶ Rounding of the Dual
- ▶ Primal Dual
- ▶ Greedy
- ▶ Randomized Rounding
- ▶ Local Search
- ▶ Rounding Data + Dynamic Programming

Scheduling Jobs on Identical Parallel Machines

Given n jobs, where job $j \in \{1, \dots, n\}$ has processing time p_j .
Schedule the jobs on m identical parallel machines such that the **Makespan** (finishing time of the last job) is minimized.

$$\begin{array}{ll} \min & L \\ \text{s.t.} & \forall \text{machines } i \quad \sum_j p_j \cdot x_{j,i} \leq L \\ & \forall \text{jobs } j \quad \sum_i x_{j,i} \geq 1 \\ & \forall i, j \quad x_{j,i} \in \{0, 1\} \end{array}$$

Here the variable $x_{j,i}$ is the decision variable that describes whether job j is assigned to machine i .

Lower Bounds on the Solution

Let for a given schedule C_j denote the finishing time of machine j , and let C_{\max} be the makespan.

Let C_{\max}^* denote the makespan of an optimal solution.

Clearly

$$C_{\max}^* \geq \max_j p_j$$

as the longest job needs to be scheduled somewhere.

Lower Bounds on the Solution

The average work performed by a machine is $\frac{1}{m} \sum_j p_j$.
Therefore,

$$C_{\max}^* \geq \frac{1}{m} \sum_j p_j$$

Local Search

A local search algorithm successively makes certain small (cost/profit improving) changes to a solution until it does not find such changes anymore.

It is conceptionally very different from a Greedy algorithm as a feasible solution is always maintained.

Sometimes the running time is difficult to prove.

Local Search for Scheduling

Local Search Strategy: Take the job that finishes last and try to move it to another machine. If there is such a move that reduces the makespan, perform the switch.

REPEAT

Local Search Analysis

Let ℓ be the job that finishes last in the produced schedule.

Let S_ℓ be its start time, and let C_ℓ be its completion time.

Note that every machine is busy before time S_ℓ , because otherwise we could move the job ℓ and hence our schedule would not be locally optimal.

We can split the total processing time into two intervals one from 0 to S_ℓ the other from S_ℓ to C_ℓ .

The interval $[S_\ell, C_\ell]$ is of length $p_\ell \leq C_{\max}^*$.

During the first interval $[0, S_\ell]$ all processors are busy, and, hence, the total work performed in this interval is

$$m \cdot S_\ell \leq \sum_{j \neq \ell} p_j .$$

Hence, the length of the schedule is at most

$$p_\ell + \frac{1}{m} \sum_{j \neq \ell} p_j = \left(1 - \frac{1}{m}\right) p_\ell + \frac{1}{m} \sum_j p_j \leq \left(2 - \frac{1}{m}\right) C_{\max}^*$$

A Tight Example

$$p_\ell \approx S_\ell + \frac{S_\ell}{m-1}$$

$$\frac{\text{ALG}}{\text{OPT}} = \frac{S_\ell + p_\ell}{p_\ell} \approx \frac{2 + \frac{1}{m-1}}{1 + \frac{1}{m-1}} = 2 - \frac{1}{m}$$

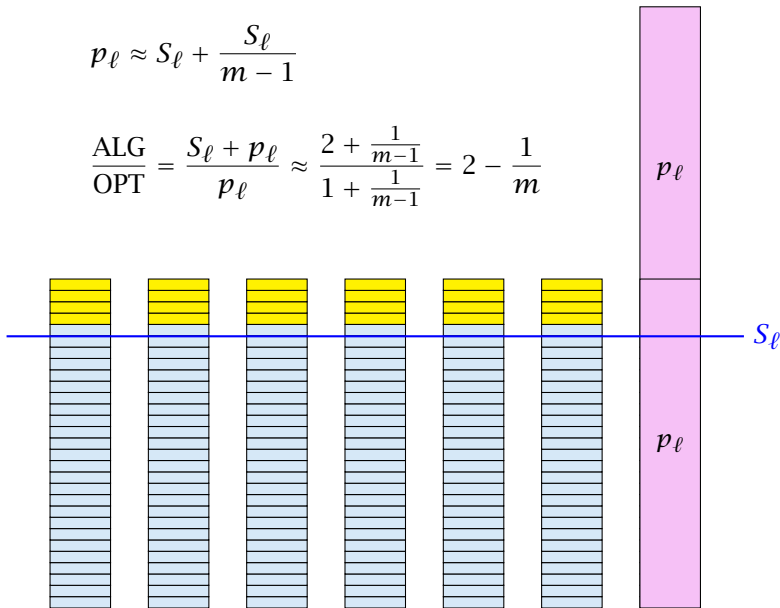

A Greedy Strategy

List Scheduling:

Order all processes in a list. When a machine runs empty assign the next yet unprocessed job to it.

Alternatively:

Consider processes in some order. Assign the i -th process to the least loaded machine.

It is easy to see that the result of these greedy strategies fulfill the local optimality condition of our local search algorithm. Hence, these also give 2-approximations.

A Greedy Strategy

Lemma 18

If we order the list according to non-increasing processing times the approximation guarantee of the list scheduling strategy improves to $4/3$.

Proof:

- ▶ Let $p_1 \geq \dots \geq p_n$ denote the processing times of a set of jobs that form a counter-example.
- ▶ Wlog. the last job to finish is n (otw. deleting this job gives another counter-example with fewer jobs).
- ▶ If $p_n \leq C_{\max}^*/3$ the previous analysis gives us a schedule length of at most

$$C_{\max}^* + p_n \leq \frac{4}{3} C_{\max}^* .$$

Hence, $p_n > C_{\max}^*/3$.

- ▶ This means that all jobs must have a processing time $> C_{\max}^*/3$.
- ▶ But then any machine in the optimum schedule can handle at most two jobs.
- ▶ For such instances Longest-Processing-Time-First is optimal.

When in an optimal solution a machine can have at most 2 jobs the optimal solution looks as follows.

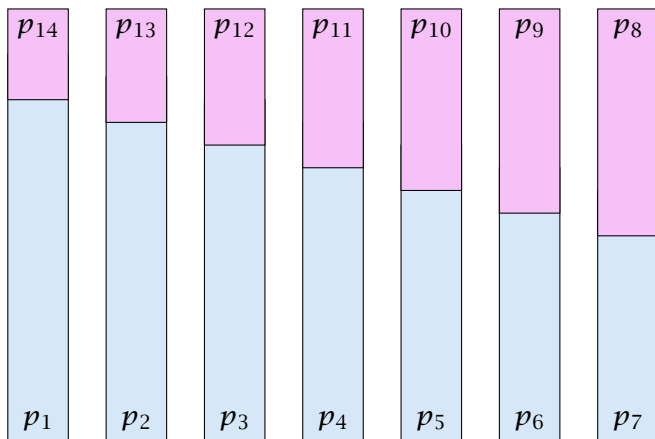

- ▶ We can assume that one machine schedules p_1 and p_n (the largest and smallest job).
- ▶ If not assume wlog. that p_1 is scheduled on machine A and p_n on machine B .
- ▶ Let p_A and p_B be the other job scheduled on A and B , respectively.
- ▶ $p_1 + p_n \leq p_1 + p_A$ and $p_A + p_B \leq p_1 + p_A$, hence scheduling p_1 and p_n on one machine and p_A and p_B on the other, cannot increase the Makespan.
- ▶ Repeat the above argument for the remaining machines.

Tight Example

- ▶ $2m + 1$ jobs
- ▶ 2 jobs with length $2m, 2m - 1, 2m - 2, \dots, m + 1$ ($2m - 2$ jobs in total)
- ▶ 3 jobs of length m

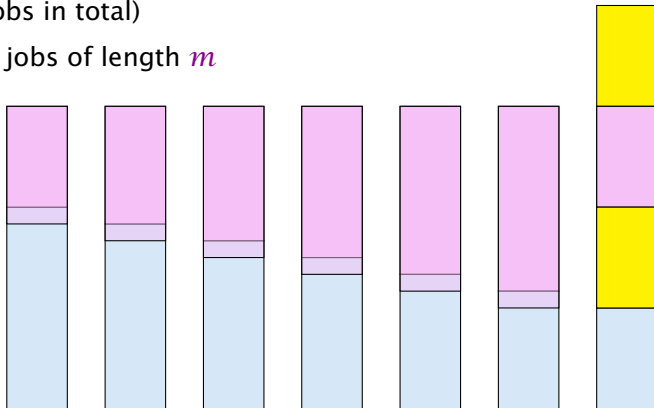

Traveling Salesman

Given a set of cities $\{1, \dots, n\}$ and a symmetric matrix $C = (c_{ij})$, $c_{ij} \geq 0$ that specifies for every pair $(i, j) \in [n] \times [n]$ the cost for travelling from city i to city j . Find a permutation π of the cities such that the round-trip cost

$$c_{\pi(1)\pi(n)} + \sum_{i=1}^{n-1} c_{\pi(i)\pi(i+1)}$$

is minimized.

Traveling Salesman

Theorem 19

There does not exist an $O(2^n)$ -approximation algorithm for TSP.

Hamiltonian Cycle:

For a given undirected graph $G = (V, E)$ decide whether there exists a simple cycle that contains all nodes in G .

- ▶ Given an instance to HAMPATH we create an instance for TSP.
- ▶ If $(i, j) \notin E$ then set c_{ij} to $n2^n$ otw. set c_{ij} to 1. This instance has polynomial size.
- ▶ There exists a Hamiltonian Path iff there exists a tour with cost n . Otw. any tour has cost strictly larger than $n2^n$.
- ▶ An $O(2^n)$ -approximation algorithm could decide btw. these cases. Hence, cannot exist unless $P = NP$.

Metric Traveling Salesman

In the metric version we assume for every triple

$i, j, k \in \{1, \dots, n\}$

$$c_{ij} \leq c_{ij} + c_{jk} .$$

It is convenient to view the input as a complete undirected graph $G = (V, E)$, where c_{ij} for an edge (i, j) defines the distance between nodes i and j .

TSP: Lower Bound I

Lemma 20

The cost $\text{OPT}_{\text{TSP}}(G)$ of an optimum traveling salesman tour is at least as large as the weight $\text{OPT}_{\text{MST}}(G)$ of a minimum spanning tree in G .

Proof:

- ▶ Take the optimum TSP-tour.
- ▶ Delete one edge.
- ▶ This gives a spanning tree of cost at most $\text{OPT}_{\text{TSP}}(G)$.

TSP: Greedy Algorithm

- ▶ Start with a tour on a subset S containing a single node.
- ▶ Take the node v closest to S . Add it S and expand the existing tour on S to include v .
- ▶ Repeat until all nodes have been processed.

TSP: Greedy Algorithm

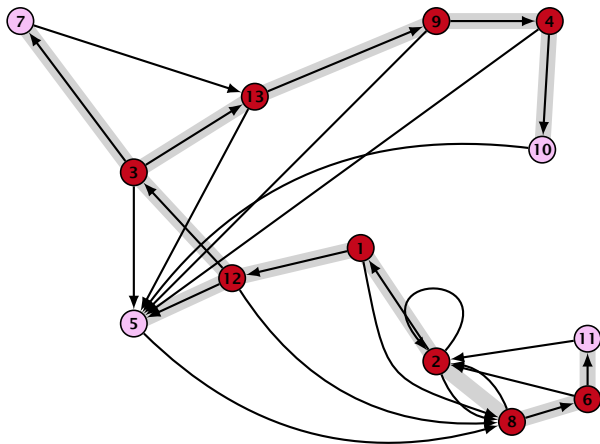

The gray edges form an MST, because exactly these edges are taken in Prim's algorithm.

TSP: Greedy Algorithm

Lemma 21

The Greedy algorithm is a 2-approximation algorithm.

Let S_i be the set at the start of the i -th iteration, and let v_i denote the node added during the iteration.

Further let $s_i \in S_i$ be the node closest to $v_i \in S_i$.

Let r_i denote the successor of s_i in the tour before inserting v_i .

We replace the edge (s_i, r_i) in the tour by the two edges (s_i, v_i) and (v_i, r_i) .

This increases the cost by

$$c_{s_i, v_i} + c_{v_i, r_i} - c_{s_i, r_i} \leq 2c_{s_i, v_i}$$

TSP: Greedy Algorithm

The edges (s_i, v_i) considered during the Greedy algorithm are exactly the edges considered during PRIMs MST algorithm.

Hence,

$$\sum_i c_{s_i, v_i} = \text{OPT}_{\text{MST}}(G)$$

which with the previous lower bound gives a 2-approximation.

TSP: A different approach

Suppose that we are given an **Eulerian** graph $G' = (V, E', c')$ of $G = (V, E, c)$ such that for any edge $(i, j) \in E'$ $c'(i, j) \geq c(i, j)$.

Then we can find a TSP-tour of cost at most

$$\sum_{e \in E'} c'(e)$$

- ▶ Find an Euler tour of G' .
- ▶ Fix a permutation of the cities (i.e., a TSP-tour) by traversing the Euler tour and only note the first occurrence of a city.
- ▶ The cost of this TSP tour is at most the cost of the Euler tour because of triangle inequality.

This technique is known as **short cutting** the Euler tour.

TSP: A different approach

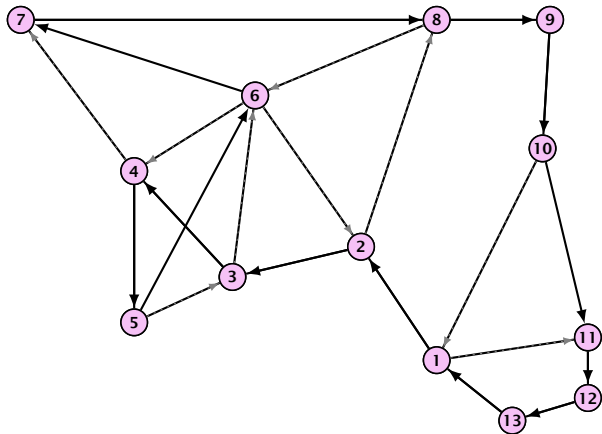

TSP: A different approach

Consider the following graph:

- ▶ Compute an MST of G .
- ▶ Duplicate all edges.

This graph is Eulerian, and the total cost of all edges is at most $2 \cdot \text{OPT}_{\text{MST}}(G)$.

Hence, short-cutting gives a tour of cost no more than $2 \cdot \text{OPT}_{\text{MST}}(G)$ which means we have a 2-approximation.

TSP: Can we do better?

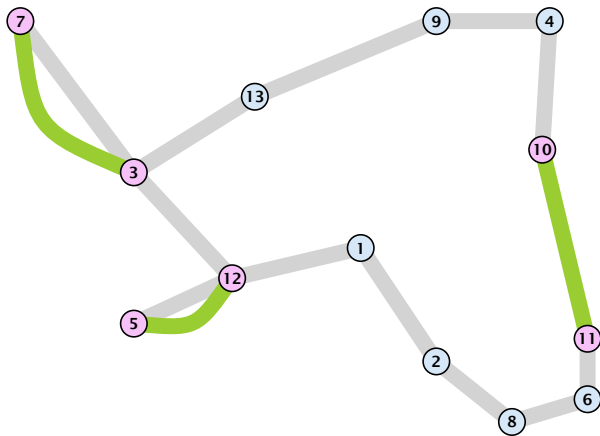

TSP: Can we do better?

Duplicating all edges in the MST seems to be rather wasteful.

We only need to make the graph Eulerian.

For this we compute a Minimum Weight Matching between odd degree vertices in the MST (note that there are an even number of them).

TSP: Can we do better?

An optimal tour on the odd-degree vertices has cost at most $\text{OPT}_{\text{TSP}}(G)$.

However, the edges of this tour give rise to two disjoint matchings. One of these matchings must have weight less than $\text{OPT}_{\text{TSP}}(G)/2$.

Adding this matching to the MST gives an Eulerian graph with edge weight at most

$$\text{OPT}_{\text{MST}}(G) + \text{OPT}_{\text{TSP}}(G)/2 \leq \frac{3}{2}\text{OPT}_{\text{TSP}}(G) ,$$

Short cutting gives a $\frac{3}{2}$ -approximation for metric TSP.

This is the best that is known.

Christofides. Tight Example

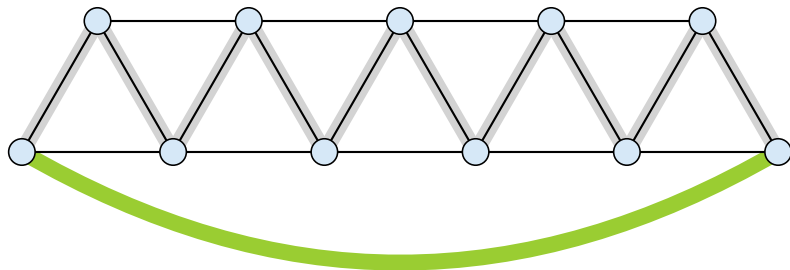

- ▶ optimal tour: n edges.
- ▶ MST: $n - 1$ edges.
- ▶ weight of matching $(n + 1)/2 - 1$
- ▶ MST+matching $\approx 3/2 \cdot n$

Tree shortcutting. Tight Example

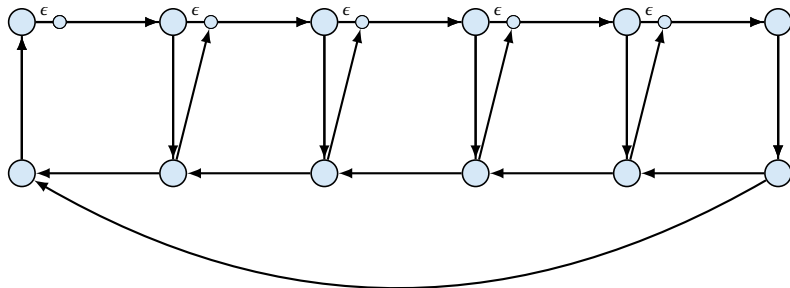

- ▶ edges have Euclidean distance.

16 Rounding Data + Dynamic Programming

Knapsack:

Given a set of items $\{1, \dots, n\}$, where the i -th item has weight $w_i \in \mathbb{N}$ and profit $p_i \in \mathbb{N}$, and given a threshold W . Find a subset $I \subseteq \{1, \dots, n\}$ of items of total weight at most W such that the profit is maximized (we can assume each $w_i \leq W$).

$$\begin{array}{ll} \max & \sum_{i=1}^n p_i x_i \\ \text{s.t.} & \sum_{i=1}^n w_i x_i \leq W \\ & \forall i \in \{1, \dots, n\} \quad x_i \in \{0, 1\} \end{array}$$

16 Rounding Data + Dynamic Programming

Algorithm 1 Knapsack

```
1:  $A(1) \leftarrow [(0, 0), (p_1, w_1)]$ 
2: for  $j \leftarrow 2$  to  $n$  do
3:    $A(j) \leftarrow A(j - 1)$ 
4:   for each  $(p, w) \in A(j - 1)$  do
5:     if  $w + w_j \leq W$  then
6:       add  $(p + p_j, w + w_j)$  to  $A(j)$ 
7:       remove dominated pairs from  $A(j)$ 
8: return  $\max_{(p,w) \in A(n)} p$ 
```

The running time is $\mathcal{O}(n \cdot \min\{W, P\})$, where $P = \sum_i p_i$ is the total profit of all items. This is only **pseudo-polynomial**.

16 Rounding Data + Dynamic Programming

Definition 22

An algorithm is said to have pseudo-polynomial running time if the running time is polynomial when the numerical part of the input is encoded in unary.

16 Rounding Data + Dynamic Programming

- ▶ Let M be the maximum profit of an element.
- ▶ Set $\mu := \epsilon M/n$.
- ▶ Set $p'_i := \lfloor p_i/\mu \rfloor$ for all i .
- ▶ Run the dynamic programming algorithm on this revised instance.

Running time is at most

$$\mathcal{O}(nP') = \mathcal{O}\left(n \sum_i p'_i\right) = \mathcal{O}\left(n \sum_i \left\lfloor \frac{p_i}{\epsilon M/n} \right\rfloor\right) \leq \mathcal{O}\left(\frac{n^3}{\epsilon}\right).$$

16 Rounding Data + Dynamic Programming

Let S be the set of items returned by the algorithm, and let O be an optimum set of items.

$$\begin{aligned}\sum_{i \in S} p_i &\geq \mu \sum_{i \in S} p'_i \\ &\geq \mu \sum_{i \in O} p'_i \\ &\geq \sum_{i \in O} p_i - |O|\mu \\ &\geq \sum_{i \in O} p_i - n\mu \\ &= \sum_{i \in O} p_i - \epsilon M \\ &\geq (1 - \epsilon)\text{OPT} .\end{aligned}$$

Scheduling Revisited

The previous analysis of the scheduling algorithm gave a makespan of

$$\frac{1}{m} \sum_{j \neq \ell} p_j + p_\ell$$

where ℓ is the last job to complete.

Together with the observation that if each $p_i \geq \frac{1}{3} C_{\max}^*$ then LPT is optimal this gave a $4/3$ -approximation.

16.2 Scheduling Revisited

Partition the input into **long** jobs and **short** jobs.

A job j is called short if

$$p_j \leq \frac{1}{km} \sum_i p_i$$

Idea:

1. Find the optimum Makespan for the long jobs by brute force.
2. Then use the list scheduling algorithm for the short jobs, always assigning the next job to the least loaded machine.

We still have a cost of

$$\frac{1}{m} \sum_{j \neq \ell} p_j + p_\ell$$

where ℓ is the last job (this only requires that all machines are busy before time S_ℓ).

If ℓ is a long job, then the schedule must be optimal, as it consists of an optimal schedule of long jobs plus a schedule for short jobs.

If ℓ is a short job its length is at most

$$p_\ell \leq \sum_j p_j / (mk)$$

which is at most C_{\max}^* / k .

Hence we get a schedule of length at most

$$\left(1 + \frac{1}{k}\right) C_{\max}^*$$

There are at most km long jobs. Hence, the number of possibilities of scheduling these jobs on m machines is at most m^{km} , which is constant if m is constant. Hence, it is easy to implement the algorithm in polynomial time.

Theorem 23

The above algorithm gives a polynomial time approximation scheme (PTAS) for the problem of scheduling n jobs on m identical machines if m is constant.

We choose $k = \lceil \frac{1}{\epsilon} \rceil$.

How to get rid of the requirement that m is constant?

We first design an algorithm that works as follows:

On input of T it either finds a schedule of length $(1 + \frac{1}{k})T$ or certifies that no schedule of length at most T exists (assume $T \geq \frac{1}{m} \sum_j p_j$).

We partition the jobs into **long** jobs and **short** jobs:

- ▶ A job is long if its size is larger than T/k .
- ▶ Otw. it is a short job.

- ▶ We round all **long jobs** down to multiples of T/k^2 .
- ▶ For these rounded sizes we first find an optimal schedule.
- ▶ If this schedule does not have length at most T we conclude that also the original sizes don't allow such a schedule.
- ▶ If we have a good schedule we extend it by adding the short jobs according to the LPT rule.

After the first phase the rounded sizes of the long jobs assigned to a machine add up to at most T .

There can be at most k (long) jobs assigned to a machine as otherwise their rounded sizes would add up to more than T (note that the rounded size of a long job is at least T/k).

Since, jobs had been rounded to multiples of T/k^2 going from rounded sizes to original sizes gives that the Makespan is at most

$$\left(1 + \frac{1}{k}\right)T .$$

During the second phase there always must exist a machine with load at most T , since T is larger than the average load. Assigning the current (short) job to such a machine gives that the new load is at most

$$T + \frac{T}{k} \leq \left(1 + \frac{1}{k}\right)T .$$

Running Time for scheduling large jobs: There should not be a job with rounded size more than T as otw. the problem becomes trivial.

Hence, any large job has rounded size of $\frac{i}{k^2}T$ for $i \in \{k, \dots, k^2\}$. Therefore the number of different inputs is at most n^{k^2} (described by a vector of length k^2 where, the i -th entry describes the number of jobs of size $\frac{i}{k^2}T$). **This is polynomial.**

The schedule/configuration of a particular machine x can be described by a vector of length k^2 where the i -th entry describes the number of jobs of rounded size $\frac{i}{k^2}T$ assigned to x . There are only $(k + 1)^{k^2}$ different vectors.

This means there are **a constant** number of different machine configurations.

Let $\text{OPT}(n_1, \dots, n_{k^2})$ be the **number of machines** that are required to schedule input vector (n_1, \dots, n_{k^2}) with Makespan at most T .

If $\text{OPT}(n_1, \dots, n_{k^2}) \leq m$ we can schedule the input.

We have

$$\text{OPT}(n_1, \dots, n_{k^2}) = \begin{cases} 0 & (n_1, \dots, n_{k^2}) = 0 \\ 1 + \min_{(s_1, \dots, s_{k^2}) \in C} \text{OPT}(n_1 - s_1, \dots, n_{k^2} - s_{k^2}) & (n_1, \dots, n_{k^2}) \not\equiv 0 \\ \infty & \text{otw.} \end{cases}$$

where C is the set of all configurations.

Hence, the running time is roughly $(k+1)^{k^2} n^{k^2} \approx (nk)^{k^2}$.

We can turn this into a PTAS by choosing $k = \lceil 1/\epsilon \rceil$ and using binary search. This gives a running time that is exponential in $1/\epsilon$.

Can we do better?

Scheduling on identical machines with the goal of minimizing Makespan is a **strongly NP-complete** problem.

Theorem 24

There is no FPTAS for problems that are strongly NP-hard.

- ▶ Suppose we have an instance with polynomially bounded processing times $p_i \leq q(n)$
- ▶ We set $k := \lceil 2nq(n) \rceil \geq 2 \text{OPT}$
- ▶ Then

$$\text{ALG} \leq \left(1 + \frac{1}{k}\right) \text{OPT} \leq \text{OPT} + \frac{1}{2}$$

- ▶ But this means that the algorithm computes the optimal solution as the optimum is integral.
- ▶ This means we can solve problem instances if processing times are polynomially bounded
- ▶ Running time is $\mathcal{O}(\text{poly}(n, k)) = \mathcal{O}(\text{poly}(n))$
- ▶ For strongly NP-complete problems this is not possible unless $P=NP$

More General

Let $\text{OPT}(n_1, \dots, n_A)$ be the number of machines that are required to schedule input vector (n_1, \dots, n_A) with Makespan at most T (A : number of different sizes).

If $\text{OPT}(n_1, \dots, n_A) \leq m$ we can schedule the input.

$$\text{OPT}(n_1, \dots, n_A)$$

$$= \begin{cases} 0 & (n_1, \dots, n_A) = 0 \\ 1 + \min_{(s_1, \dots, s_A) \in C} \text{OPT}(n_1 - s_1, \dots, n_A - s_A) & (n_1, \dots, n_A) \geq 0 \\ \infty & \text{otw.} \end{cases}$$

where C is the set of all configurations.

$|C| \leq (B + 1)^A$, where B is the number of jobs that possibly can fit on the same machine.

The running time is then $O((B + 1)^A n^A)$ because the dynamic programming table has just n^A entries.

Bin Packing

Given n items with sizes s_1, \dots, s_n where

$$1 > s_1 \geq \dots \geq s_n > 0 .$$

Pack items into a minimum number of bins where each bin can hold items of total size at most 1.

Theorem 25

There is no ρ -approximation for Bin Packing with $\rho < 3/2$ unless $P = NP$.

Bin Packing

Proof

- ▶ In the partition problem we are given positive integers b_1, \dots, b_n with $B = \sum_i b_i$ even. Can we partition the integers into two sets S and T s.t.

$$\sum_{i \in S} b_i = \sum_{i \in T} b_i \quad ?$$

- ▶ We can solve this problem by setting $s_i := 2b_i/B$ and asking whether we can pack the resulting items into 2 bins or not.
- ▶ A ρ -approximation algorithm with $\rho < 3/2$ cannot output 3 or more bins when 2 are optimal.
- ▶ Hence, such an algorithm can solve Partition.

Definition 26

An asymptotic polynomial-time approximation scheme (APTAS) is a family of algorithms $\{A_\epsilon\}$ along with a constant c such that A_ϵ returns a solution of value at most $(1 + \epsilon)\text{OPT} + c$ for minimization problems.

- ▶ Note that for Set Cover or for Knapsack it makes no sense to differentiate between the notion of a PTAS or an APTAS because of scaling.
- ▶ However, we will develop an APTAS for Bin Packing.

Bin Packing

Again we can differentiate between small and large items.

Lemma 27

Any packing of items into ℓ bins can be extended with items of size at most γ s.t. we use only $\max\{\ell, \frac{1}{1-\gamma}\text{SIZE}(I) + 1\}$ bins, where $\text{SIZE}(I) = \sum_i s_i$ is the sum of all item sizes.

- ▶ If after Greedy we use more than ℓ bins, all bins (apart from the last) must be full to at least $1 - \gamma$.
- ▶ Hence, $r(1 - \gamma) \leq \text{SIZE}(I)$ where r is the number of nearly-full bins.
- ▶ This gives the lemma.

Choose $\gamma = \epsilon/2$. Then we either use ℓ bins or at most

$$\frac{1}{1 - \epsilon/2} \cdot \text{OPT} + 1 \leq (1 + \epsilon) \cdot \text{OPT} + 1$$

bins.

It remains to find an algorithm for the large items.

Linear Grouping:

Generate an instance I' (for large items) as follows.

- ▶ Order large items according to size.
- ▶ Let the first k items belong to group 1; the following k items belong to group 2; etc.
- ▶ Delete items in the first group;
- ▶ Round items in the remaining groups to the size of the largest item in the group.

Linear Grouping

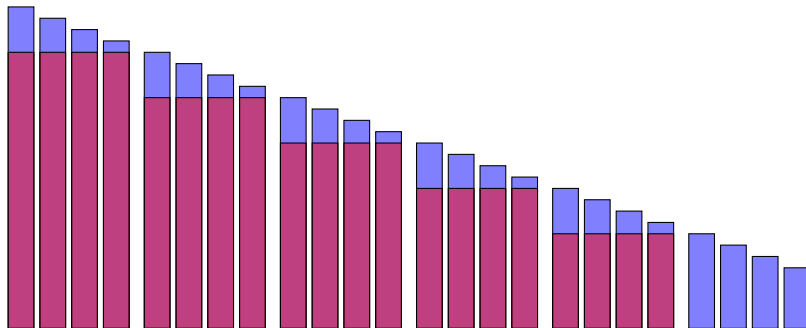

Lemma 28

$$\text{OPT}(I') \leq \text{OPT}(I) \leq \text{OPT}(I') + k$$

Proof 1:

- ▶ Any bin packing for I gives a bin packing for I' as follows.
- ▶ Pack the items of group 2, where in the packing for I the items for group 1 have been packed;
- ▶ Pack the items of groups 3, where in the packing for I the items for group 2 have been packed;
- ▶ ...

Lemma 29

$$\text{OPT}(I') \leq \text{OPT}(I) \leq \text{OPT}(I') + k$$

Proof 2:

- ▶ Any bin packing for I' gives a bin packing for I as follows.
- ▶ Pack the items of group 1 into k new bins;
- ▶ Pack the items of groups 2, where in the packing for I' the items for group 2 have been packed;
- ▶ ...

Assume that our instance does not contain pieces smaller than $\epsilon/2$. Then $\text{SIZE}(I) \geq \epsilon n/2$.

We set $k = \lfloor \epsilon \text{SIZE}(I) \rfloor$.

Then $n/k \leq n/\lfloor \epsilon^2 n/2 \rfloor \leq 4/\epsilon^2$ (here we used $\lfloor \alpha \rfloor \geq \alpha/2$ for $\alpha \geq 1$).

Hence, after grouping we have a constant number of piece sizes ($4/\epsilon^2$) and at most a constant number ($2/\epsilon$) can fit into any bin.

We can find an optimal packing for such instances by the previous Dynamic Programming approach.

- ▶ cost (for large items) at most

$$\text{OPT}(I') + k \leq \text{OPT}(I) + \epsilon \text{SIZE}(I) \leq (1 + \epsilon) \text{OPT}(I)$$

- ▶ running time $\mathcal{O}((\frac{2}{\epsilon}n)^{4/\epsilon^2})$.

Can we do better?

In the following we show how to obtain a solution where the number of bins is only

$$\text{OPT}(I) + \mathcal{O}(\log^2(\text{SIZE}(I))) .$$

Note that this is usually better than a guarantee of

$$(1 + \epsilon)\text{OPT}(I) + 1 .$$

Change of Notation:

- ▶ Group pieces of identical size.
- ▶ Let s_1 denote the largest size, and let b_1 denote the number of pieces of size s_1 .
- ▶ s_2 is second largest size and b_2 number of pieces of size s_2 ;
- ▶ ...
- ▶ s_m smallest size and b_m number of pieces of size s_m .

Configuration LP

A possible packing of a bin can be described by an m -tuple (t_1, \dots, t_m) , where t_i describes the number of pieces of size s_i . Clearly,

$$\sum_i t_i \cdot s_i \leq 1 .$$

We call a vector that fulfills the above constraint a **configuration**.

Configuration LP

Let N be the number of configurations (**exponential**).

Let T_1, \dots, T_N be the sequence of all possible configurations (a configuration T_j has T_{ji} pieces of size s_i).

$$\begin{array}{ll} \min & \sum_{j=1}^N x_j \\ \text{s.t.} & \forall i \in \{1 \dots m\} \quad \sum_{j=1}^N T_{ji} x_j \geq b_i \\ & \forall j \in \{1, \dots, N\} \quad x_j \geq 0 \\ & \forall j \in \{1, \dots, N\} \quad x_j \text{ integral} \end{array}$$

How to solve this LP?

later...

We can assume that each item has size at least $1/\text{SIZE}(I)$.

Harmonic Grouping

- ▶ Sort items according to size (monotonically decreasing).
- ▶ Process items in this order; close the current group if size of items in the group is at least 2 (or larger). Then open new group.
- ▶ I.e., G_1 is the smallest cardinality set of largest items s.t. total size sums up to at least 2. Similarly, for G_2, \dots, G_{r-1} .
- ▶ Only the size of items in the last group G_r may sum up to less than 2.

Harmonic Grouping

From the grouping we obtain instance I' as follows:

- ▶ Round all items in a group to the size of the largest group member.
- ▶ Delete all items from group G_1 and G_r .
- ▶ For groups G_2, \dots, G_{r-1} delete $n_i - n_{i-1}$ items.
- ▶ Observe that $n_i \geq n_{i-1}$.

Lemma 30

The number of different sizes in I' is at most $\text{SIZE}(I)/2$.

- ▶ Each group that survives (recall that G_1 and G_r are deleted) has total size at least 2.
- ▶ Hence, the number of surviving groups is at most $\text{SIZE}(I)/2$.
- ▶ All items in a group have the same size in I' .

Lemma 31

The total size of deleted items is at most $\mathcal{O}(\log(\text{SIZE}(I)))$.

- ▶ The total size of items in G_1 and G_r is at most 6 as a group has total size at most 3.
- ▶ Consider a group G_i that has strictly more items than G_{i-1} .
- ▶ It discards $n_i - n_{i-1}$ pieces of total size at most

$$3 \frac{n_i - n_{i-1}}{n_i} \leq \sum_{j=n_{i-1}+1}^{n_i} \frac{3}{j}$$

since the smallest piece has size at most $3/n_i$.

- ▶ Summing over all i that have $n_i > n_{i-1}$ gives a bound of at most

$$\sum_{j=1}^{n_{r-1}} \frac{3}{j} \leq \mathcal{O}(\log(\text{SIZE}(I))) .$$

(note that $n_r \leq \text{SIZE}(I)$ since we assume that the size of each item is at least $1/\text{SIZE}(I)$).

Algorithm 1 BinPack

- 1: **if** $\text{SIZE}(I) < 10$ **then**
- 2: pack remaining items greedily
- 3: Apply harmonic grouping to create instance I' ; pack discarded items in at most $\mathcal{O}(\log(\text{SIZE}(I)))$ bins.
- 4: Let x be optimal solution to configuration LP
- 5: Pack $\lfloor x_j \rfloor$ bins in configuration T_j for all j ; call the packed instance I_1 .
- 6: Let I_2 be remaining pieces from I'
- 7: Pack I_2 via $\text{BinPack}(I_2)$

$$\text{OPT}_{\text{LP}}(I_1) + \text{OPT}_{\text{LP}}(I_2) \leq \text{OPT}_{\text{LP}}(I') \leq \text{OPT}_{\text{LP}}(I)$$

Proof:

- ▶ Each piece surviving in I' can be mapped to a piece in I of no lesser size. Hence, $\text{OPT}_{\text{LP}}(I') \leq \text{OPT}_{\text{LP}}(I)$
- ▶ $\lfloor x_j \rfloor$ is feasible solution for I_1 (even integral).
- ▶ $x_j - \lfloor x_j \rfloor$ is feasible solution for I_2 .

Analysis

Each level of the recursion partitions pieces into three types

1. Pieces discarded at this level.
2. Pieces scheduled because they are in I_1 .
3. Pieces in I_2 are handed down to the next level.

Pieces of type 2 summed over all recursion levels are packed into at most OPT_{LP} many bins.

Pieces of type 1 are packed into at most

$$\mathcal{O}(\log(\text{SIZE}(I))) \cdot L$$

many bins where L is the number of recursion levels.

Analysis

We can show that $\text{SIZE}(I_2) \leq \text{SIZE}(I)/2$. Hence, the number of recursion levels is only $\mathcal{O}(\log(\text{SIZE}(I_{\text{original}})))$ in total.

- ▶ The number of non-zero entries in the solution to the configuration LP for I' is at most the number of constraints, which is the number of different sizes ($\leq \text{SIZE}(I)/2$).
- ▶ The total size of items in I_2 can be at most $\sum_{j=1}^N x_j - \lfloor x_j \rfloor$ which is at most the number of non-zero entries in the solution to the configuration LP.

How to solve the LP?

Let T_1, \dots, T_N be the sequence of all possible configurations (a configuration T_j has T_{ji} pieces of size s_i).

In total we have b_i pieces of size s_i .

Primal

$$\begin{array}{ll} \min & \sum_{j=1}^N x_j \\ \text{s.t.} & \forall i \in \{1 \dots m\} \quad \sum_{j=1}^N T_{ji} x_j \geq b_i \\ & \forall j \in \{1, \dots, N\} \quad x_j \geq 0 \end{array}$$

Dual

$$\begin{array}{ll} \max & \sum_{i=1}^m y_i b_i \\ \text{s.t.} & \forall j \in \{1, \dots, N\} \quad \sum_{i=1}^m T_{ji} y_i \leq 1 \\ & \forall i \in \{1, \dots, m\} \quad y_i \geq 0 \end{array}$$

Separation Oracle

Suppose that I am given variable assignment \mathbf{y} for the dual.

How do I find a violated constraint?

I have to find a configuration $T_j = (T_{j1}, \dots, T_{jm})$ that

- ▶ is feasible, i.e.,

$$\sum_{i=1}^m T_{ji} \cdot s_i \leq 1 ,$$

- ▶ and has a large profit

$$\sum_{i=1}^m T_{ji} \mathcal{Y}_i > 1$$

But this is the Knapsack problem.

Separation Oracle

We have FPTAS for Knapsack. This means if a constraint is violated with $1 + \epsilon' = 1 + \frac{\epsilon}{1-\epsilon}$ we find it, since we can obtain at least $(1 - \epsilon)$ of the optimal profit.

The solution we get is feasible for:

Dual'

$$\begin{array}{ll} \max & \sum_{i=1}^m y_i b_i \\ \text{s.t.} & \forall j \in \{1, \dots, N\} \quad \sum_{i=1}^m T_{ji} y_i \leq 1 + \epsilon' \\ & \forall i \in \{1, \dots, m\} \quad y_i \geq 0 \end{array}$$

Primal'

$$\begin{array}{ll} \min & (1 + \epsilon') \sum_{j=1}^N x_j \\ \text{s.t.} & \forall i \in \{1 \dots m\} \quad \sum_{j=1}^N T_{ji} x_j \geq b_i \\ & \forall j \in \{1, \dots, N\} \quad x_j \geq 0 \end{array}$$

Separation Oracle

If the value of the computed dual solution (which may be infeasible) is z then

$$\text{OPT} \leq z \leq (1 + \epsilon')\text{OPT}$$

How do we get good primal solution (not just the value)?

- ▶ The constraints used when computing z **certify** that the solution is feasible for **DUAL'**.
- ▶ Suppose that we drop all unused constraints in **DUAL**. We will compute the same solution feasible for **DUAL'**.
- ▶ Let **DUAL''** be **DUAL** without unused constraints.
- ▶ The dual to **DUAL''** is **PRIMAL** where we ignore variables for which the corresponding dual constraint has not been used.
- ▶ The optimum value for **PRIMAL''** is at most $(1 + \epsilon')\text{OPT}$.
- ▶ We can compute the corresponding solution in polytime.

This gives that overall we need at most

$$(1 + \epsilon') \text{OPT}_{\text{LP}}(I) + \mathcal{O}(\log^2(\text{SIZE}(I)))$$

bins.

We can choose $\epsilon' = \frac{1}{\text{OPT}}$ as $\text{OPT} \leq \# \text{items}$ and since we have a **fully polynomial time approximation scheme (FPTAS)** for knapsack.

Lemma 32 (Chernoff Bounds)

Let X_1, \dots, X_n be n *independent* 0-1 random variables, not necessarily identically distributed. Then for $X = \sum_{i=1}^n X_i$ and $\mu = E[X]$, $L \leq \mu \leq U$, and $\delta > 0$

$$\Pr[X \geq (1 + \delta)U] < \left(\frac{e^\delta}{(1 + \delta)^{1+\delta}} \right)^U,$$

and

$$\Pr[X \leq (1 - \delta)L] < \left(\frac{e^{-\delta}}{(1 - \delta)^{1-\delta}} \right)^L,$$

Lemma 33

For $0 \leq \delta \leq 1$ we have that

$$\left(\frac{e^\delta}{(1+\delta)^{1+\delta}} \right)^U \leq e^{-U\delta^2/3}$$

and

$$\left(\frac{e^{-\delta}}{(1-\delta)^{1-\delta}} \right)^L \leq e^{-L\delta^2/2}$$

Proof of Chernoff Bounds

Markovs Inequality:

Let X be random variable taking non-negative values.

Then

$$\Pr[X \geq a] \leq E[X]/a$$

Trivial!

Proof of Chernoff Bounds

Hence:

$$\Pr[X \geq (1 + \delta)U] \leq \frac{E[X]}{(1 + \delta)U} \approx \frac{1}{1 + \delta}$$

That's awfully weak :(

Proof of Chernoff Bounds

Set $p_i = \Pr[X_i = 1]$. Assume $p_i > 0$ for all i .

Cool Trick:

$$\Pr[X \geq (1 + \delta)U] = \Pr[e^{tX} \geq e^{t(1+\delta)U}]$$

Now, we apply Markov:

$$\Pr[e^{tX} \geq e^{t(1+\delta)U}] \leq \frac{\mathbb{E}[e^{tX}]}{e^{t(1+\delta)U}} .$$

This may be a lot better (!?)

Proof of Chernoff Bounds

$$\mathbb{E} \left[e^{tX} \right] = \mathbb{E} \left[e^{t \sum_i X_i} \right] = \mathbb{E} \left[\prod_i e^{tX_i} \right] = \prod_i \mathbb{E} \left[e^{tX_i} \right]$$

$$\mathbb{E} \left[e^{tX_i} \right] = (1 - p_i) + p_i e^t = 1 + p_i(e^t - 1) \leq e^{p_i(e^t - 1)}$$

$$\prod_i \mathbb{E} \left[e^{tX_i} \right] \leq \prod_i e^{p_i(e^t - 1)} = e^{\sum p_i(e^t - 1)} = e^{(e^t - 1)U}$$

Now, we apply Markov:

$$\begin{aligned}\Pr[X \geq (1 + \delta)U] &= \Pr[e^{tX} \geq e^{t(1+\delta)U}] \\ &\leq \frac{\mathbb{E}[e^{tX}]}{e^{t(1+\delta)U}} \leq \frac{e^{(e^t-1)U}}{e^{t(1+\delta)U}} \leq \left(\frac{e^\delta}{(1 + \delta)^{1+\delta}}\right)^U\end{aligned}$$

We choose $t = \ln(1 + \delta)$.

Lemma 34

For $0 \leq \delta \leq 1$ we have that

$$\left(\frac{e^\delta}{(1+\delta)^{1+\delta}} \right)^U \leq e^{-U\delta^2/3}$$

and

$$\left(\frac{e^{-\delta}}{(1-\delta)^{1-\delta}} \right)^L \leq e^{-L\delta^2/2}$$

Show:

$$\left(\frac{e^\delta}{(1+\delta)^{1+\delta}} \right)^U \leq e^{-U\delta^2/3}$$

Take logarithms:

$$U(\delta - (1+\delta)\ln(1+\delta)) \leq -U\delta^2/3$$

True for $\delta = 0$. Divide by U and take derivatives:

$$-\ln(1+\delta) \leq -2\delta/3$$

Reason:

As long as derivative of left side is smaller than derivative of right side the inequality holds.

$$f(\delta) := -\ln(1 + \delta) + 2\delta/3 \leq 0$$

A convex function ($f''(\delta) \geq 0$) on an interval takes maximum at the boundaries.

$$f'(\delta) = -\frac{1}{1 + \delta} + 2/3 \quad f''(\delta) = \frac{1}{(1 + \delta)^2}$$

$$f(0) = 0 \text{ and } f(1) = -\ln(2) + 2/3 < 0$$

For $\delta \geq 1$ we show

$$\left(\frac{e^\delta}{(1+\delta)^{1+\delta}} \right)^U \leq e^{-U\delta/3}$$

Take logarithms:

$$U(\delta - (1+\delta)\ln(1+\delta)) \leq -U\delta/3$$

True for $\delta = 0$. Divide by U and take derivatives:

$$-\ln(1+\delta) \leq -1/3 \iff \ln(1+\delta) \geq 1/3 \quad (\text{true})$$

Reason:

As long as derivative of left side is smaller than derivative of right side the inequality holds.

Show:

$$\left(\frac{e^{-\delta}}{(1-\delta)^{1-\delta}} \right)^L \leq e^{-L\delta^2/2}$$

Take logarithms:

$$L(-\delta - (1-\delta)\ln(1-\delta)) \leq -L\delta^2/2$$

True for $\delta = 0$. Divide by L and take derivatives:

$$\ln(1-\delta) \leq -\delta$$

Reason:

As long as derivative of left side is smaller than derivative of right side the inequality holds.

$$\ln(1 - \delta) \leq -\delta$$

True for $\delta = 0$. Take derivatives:

$$-\frac{1}{1 - \delta} \leq -1$$

This holds for $0 \leq \delta < 1$.

Integer Multicommodity Flows

- ▶ Given s_i - t_i pairs in a graph.
- ▶ Connect each pair by a path such that not too many paths use any given edge.

$$\begin{array}{ll} \min & W \\ \text{s.t.} & \forall i \quad \sum_{p \in \mathcal{P}_i} x_p = 1 \\ & \sum_{p: e \in p} x_p \leq W \\ & x_p \in \{0, 1\} \end{array}$$

Integer Multicommodity Flows

Randomized Rounding:

For each i choose one path from the set \mathcal{P}_i at random according to the probability distribution given by the Linear Programming solution.

Theorem 35

If $W^* \geq c \ln n$ for some constant c , then with probability at least $n^{-c/3}$ the total number of paths using any edge is at most $W^* + \sqrt{cW^* \ln n}$.

Theorem 36

With probability at least $n^{-c/3}$ the total number of paths using any edge is at most $W^* + c \ln n$.

Integer Multicommodity Flows

Let X_e^i be a random variable that indicates whether the path for s_i - t_i uses edge e .

Then the number of paths using edge e is $Y_e = \sum_i X_e^i$.

$$E[Y_e] = \sum_i \sum_{p \in \mathcal{P}_i; e \in p} x_p^* = \sum_{p: e \in p} x_p^* \leq W^*$$

Integer Multicommodity Flows

Choose $\delta = \sqrt{(c \ln n)/W^*}$.

Then

$$\Pr[Y_e \geq (1 + \delta)W^*] < e^{-W^* \delta^2/3} = \frac{1}{n^{c/3}}$$

17.3 MAXSAT

Problem definition:

- ▶ n Boolean variables
- ▶ m clauses C_1, \dots, C_m . For example

$$C_7 = x_3 \vee \bar{x}_5 \vee \bar{x}_9$$

- ▶ Non-negative weight w_j for each clause C_j .
- ▶ Find an assignment of true/false to the variables such that the total weight of clauses that are **satisfied** is maximum.

Terminology:

- ▶ A variable x_i and its negation \bar{x}_i are called **literals**.
- ▶ Hence, each clause consists of a set of literals (i.e., no duplications: $x_i \vee x_i \vee \bar{x}_j$ is **not** a clause).
- ▶ We assume a clause does not contain x_i and \bar{x}_i for any i .
- ▶ x_i is called a **positive literal** while the negation \bar{x}_i is called a **negative literal**.
- ▶ For a given clause C_j the number of its literals is called its **length** or **size** and denoted with ℓ_j .
- ▶ Clauses of length one are called **unit clauses**.

MAXSAT: Flipping Coins

Set each x_i independently to **true** with probability $\frac{1}{2}$ (and, hence, to **false** with probability $\frac{1}{2}$, as well).

Define random variable X_j with

$$X_j = \begin{cases} 1 & \text{if } C_j \text{ satisfied} \\ 0 & \text{otw.} \end{cases}$$

Then the total weight W of satisfied clauses is given by

$$W = \sum_j w_j X_j$$

$$\begin{aligned} E[W] &= \sum_j w_j E[X_j] \\ &= \sum_j w_j \Pr[C_j \text{ is satisfied}] \\ &= \sum_j w_j \left(1 - \left(\frac{1}{2}\right)^{\ell_j}\right) \\ &\geq \frac{1}{2} \sum_j w_j \\ &\geq \frac{1}{2} \text{OPT} \end{aligned}$$

MAXSAT: LP formulation

- ▶ Let for a clause C_j , P_j be the set of positive literals and N_j the set of negative literals.

$$C_j = \bigvee_{i \in P_j} x_i \vee \bigvee_{i \in N_j} \bar{x}_i$$

$$\begin{array}{ll} \max & \sum_j w_j z_j \\ \text{s.t.} & \forall j \quad \sum_{i \in P_j} y_i + \sum_{i \in N_j} (1 - y_i) \geq z_j \\ & \forall i \quad y_i \in \{0, 1\} \\ & \forall j \quad z_j \leq 1 \end{array}$$

MAXSAT: Randomized Rounding

Set each x_i independently to **true** with probability y_i (and, hence, to **false** with probability $(1 - y_i)$).

Lemma 37 (Geometric Mean \leq Arithmetic Mean)

For any nonnegative a_1, \dots, a_k

$$\left(\prod_{i=1}^k a_i \right)^{1/k} \leq \frac{1}{k} \sum_{i=1}^k a_i$$

Definition 38

A function f on an interval I is **concave** if for any two points s and r from I and any $\lambda \in [0, 1]$ we have

$$f(\lambda s + (1 - \lambda)r) \geq \lambda f(s) + (1 - \lambda)f(r)$$

Lemma 39

Let f be a concave function on the interval $[0, 1]$, with $f(0) = a$ and $f(1) = a + b$. Then

$$\begin{aligned} f(\lambda) &= f((1 - \lambda)0 + \lambda 1) \\ &\geq (1 - \lambda)f(0) + \lambda f(1) \\ &= a + \lambda b \end{aligned}$$

for $\lambda \in [0, 1]$.

$$\begin{aligned}
\Pr[C_j \text{ not satisfied}] &= \prod_{i \in P_j} (1 - y_i) \prod_{i \in N_j} y_i \\
&\leq \left[\frac{1}{\ell_j} \left(\sum_{i \in P_j} (1 - y_i) + \sum_{i \in N_j} y_i \right) \right]^{\ell_j} \\
&= \left[1 - \frac{1}{\ell_j} \left(\sum_{i \in P_j} y_i + \sum_{i \in N_j} (1 - y_i) \right) \right]^{\ell_j} \\
&\leq \left(1 - \frac{z_j}{\ell_j} \right)^{\ell_j} .
\end{aligned}$$

The function $f(z) = 1 - (1 - \frac{z}{\ell})^\ell$ is concave. Hence,

$$\begin{aligned}\Pr[C_j \text{ satisfied}] &\geq 1 - \left(1 - \frac{z_j}{\ell_j}\right)^{\ell_j} \\ &\geq \left[1 - \left(1 - \frac{1}{\ell_j}\right)^{\ell_j}\right] \cdot z_j .\end{aligned}$$

$f''(z) = -\frac{\ell-1}{\ell} \left[1 - \frac{z}{\ell}\right]^{\ell-2} \leq 0$ for $z \in [0, 1]$. Therefore, f is concave.

$$\begin{aligned} E[W] &= \sum_j w_j \Pr[C_j \text{ is satisfied}] \\ &\geq \sum_j w_j z_j \left[1 - \left(1 - \frac{1}{\ell_j} \right)^{\ell_j} \right] \\ &\geq \left(1 - \frac{1}{e} \right) \text{OPT} . \end{aligned}$$

MAXSAT: The better of two

Theorem 40

Choosing the better of the two solutions given by randomized rounding and coin flipping yields a $\frac{3}{4}$ -approximation.

Let W_1 be the value of randomized rounding and W_2 the value obtained by coin flipping.

$$\begin{aligned}
 & E[\max\{W_1, W_2\}] \\
 & \geq E\left[\frac{1}{2}W_1 + \frac{1}{2}W_2\right] \\
 & \geq \frac{1}{2} \sum_j w_j z_j \left[1 - \left(1 - \frac{1}{\ell_j}\right)^{\ell_j} \right] + \frac{1}{2} \sum_j w_j \left(1 - \left(\frac{1}{2}\right)^{\ell_j}\right) \\
 & \geq \sum_j w_j z_j \underbrace{\left[\frac{1}{2} \left(1 - \left(1 - \frac{1}{\ell_j}\right)^{\ell_j}\right) + \frac{1}{2} \left(1 - \left(\frac{1}{2}\right)^{\ell_j}\right) \right]}_{\geq \frac{3}{4} \text{ for all integers}} \\
 & \geq \frac{3}{4} \text{OPT}
 \end{aligned}$$

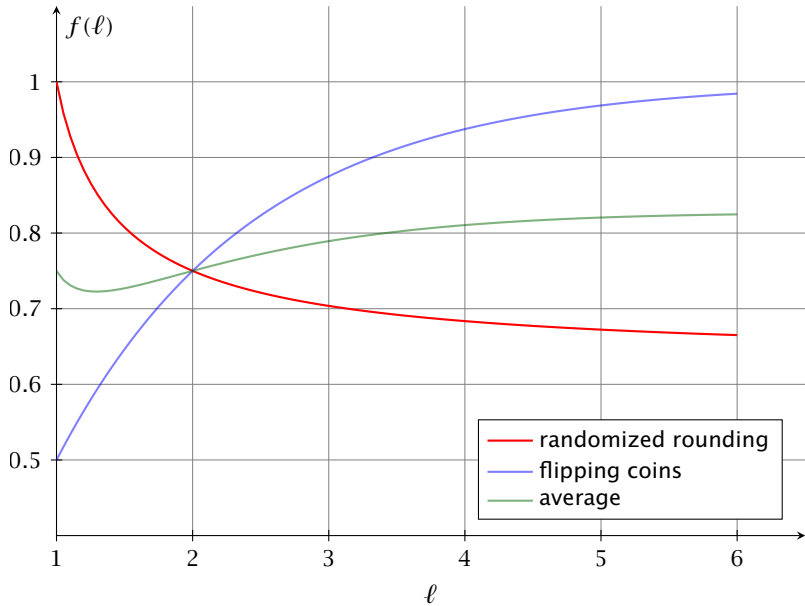

MAXSAT: Nonlinear Randomized Rounding

So far we used **linear** randomized rounding, i.e., the probability that a variable is set to 1/true was exactly the value of the corresponding variable in the linear program.

We could define a function $f : [0, 1] \rightarrow [0, 1]$ and set x_i to true with probability $f(y_i)$.

MAXSAT: Nonlinear Randomized Rounding

Let $f : [0, 1] \rightarrow [0, 1]$ be a function with

$$1 - 4^{-x} \leq f(x) \leq 4^{x-1}$$

Theorem 41

Rounding the LP-solution with a function f of the above form gives a $\frac{3}{4}$ -approximation.

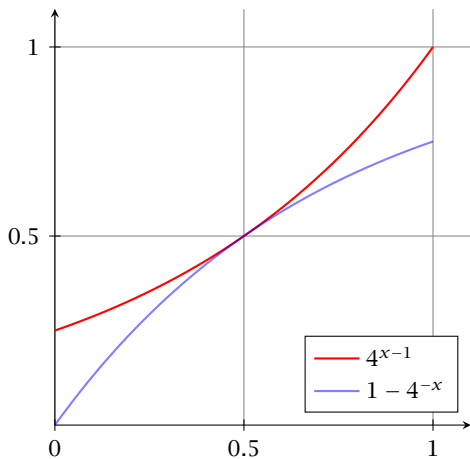

$$\begin{aligned}\Pr[C_j \text{ not satisfied}] &= \prod_{i \in P_j} (1 - f(y_i)) \prod_{i \in N_j} f(y_i) \\ &\leq \prod_{i \in P_j} 4^{-y_i} \prod_{i \in N_j} 4^{y_i - 1} \\ &= 4^{-(\sum_{i \in P_j} y_i + \sum_{i \in N_j} (1 - y_i))} \\ &\leq 4^{-z_j}\end{aligned}$$

The function $g(z) = 1 - 4^{-z}$ is concave on $[0, 1]$. Hence,

$$\Pr[C_j \text{ satisfied}] \geq 1 - 4^{-z_j} \geq \frac{3}{4}z_j .$$

Therefore,

$$E[W] = \sum_j w_j \Pr[C_j \text{ satisfied}] \geq \frac{3}{4} \sum_j w_j z_j \geq \frac{3}{4} \text{OPT}$$

Can we do better?

Not if we compare ourselves to the value of an optimum LP-solution.

Definition 42 (Integrality Gap)

The integrality gap for an ILP is the worst-case ratio over all instances of the problem of the value of an optimal IP-solution to the value of an optimal solution to its linear programming relaxation.

Note that the integrality is less than one for maximization problems and larger than one for minimization problems (of course, equality is possible).

Note that an integrality gap only holds for one specific ILP formulation.

Lemma 43

Our ILP-formulation for the MAXSAT problem has integrality gap at most $\frac{3}{4}$.

$$\begin{array}{ll} \max & \sum_j w_j z_j \\ \text{s.t.} & \forall j \quad \sum_{i \in P_j} y_i + \sum_{i \in N_j} (1 - y_i) \geq z_j \\ & \forall i \quad y_i \in \{0, 1\} \\ & \forall j \quad z_j \leq 1 \end{array}$$

Consider: $(x_1 \vee x_2) \wedge (\bar{x}_1 \vee x_2) \wedge (x_1 \vee \bar{x}_2) \wedge (\bar{x}_1 \vee \bar{x}_2)$

- ▶ any solution can satisfy at most 3 clauses
- ▶ we can set $y_1 = y_2 = 1/2$ in the LP; this allows to set $z_1 = z_2 = z_3 = z_4 = 1$
- ▶ hence, the LP has value 4.

MaxCut

Given a weighted graph $G = (V, E, w)$, $w(v) \geq 0$, partition the vertices into two parts. Maximize the weight of edges between the parts.

Trivial 2-approximation

Semidefinite Programming

$$\begin{array}{ll} \max / \min & \sum_{i,j} c_{ij} x_{ij} \\ \text{s.t.} & \forall k \quad \sum_{i,j} a_{ijk} x_{ij} = b_k \\ & \forall i, j \quad x_{ij} = x_{ji} \\ & X = (x_{ij}) \text{ is psd.} \end{array}$$

- ▶ linear objective, linear constraints
- ▶ we can constrain a square matrix of variables to be symmetric positive definite

Note that wlog. we can assume that all variables appear in this matrix. Suppose we have a non-negative scalar z and want to express something like

$$\sum_{i,j} a_{ijk} x_{ij} + z = b_k$$

where x_{ij} are variables of the positive semidefinite matrix. We can add z as a diagonal entry $x_{\ell\ell}$, and additionally introduce constraints $x_{\ell r} = 0$ and $x_{r\ell} = 0$.

Vector Programming

$$\begin{array}{ll} \max / \min & \sum_{i,j} c_{ij} (v_i^t v_j) \\ \text{s.t.} & \forall k \quad \sum_{i,j,k} a_{ijk} (v_i^t v_j) = b_k \\ & \forall i, j \quad x_{ij} = x_{ji} \\ & v_i \in \mathbb{R}^n \end{array}$$

- ▶ variables are vectors in n -dimensional space
- ▶ objective functions and constraints are linear in inner products of the vectors

This is equivalent!

Fact [without proof]

We (essentially) can solve Semidefinite Programs in polynomial time...

Quadratic Programs

Quadratic Program for MaxCut:

$$\begin{array}{ll} \max & \frac{1}{2} \sum_{i,j} w_{ij} (1 - y_i y_j) \\ \forall i & y_i \in \{-1, 1\} \end{array}$$

This is exactly MaxCut!

Semidefinite Relaxation

$$\begin{array}{ll} \max & \frac{1}{2} \sum_{i,j} w_{ij} (1 - v_i^t v_j) \\ & \forall i \quad v_i^t v_i = 1 \\ & \forall i \quad v_i \in \mathbb{R}^n \end{array}$$

- ▶ this is clearly a relaxation
- ▶ the solution will be vectors on the unit sphere

Rounding the SDP-Solution

- ▶ Choose a random vector r such that $r/\|r\|$ is uniformly distributed on the unit sphere.
- ▶ If $r^t v_i > 0$ set $y_i = 1$ else set $y_i = -1$

Rounding the SDP-Solution

Choose the i -th coordinate r_i as a Gaussian with mean 0 and variance 1, i.e., $r_i \sim \mathcal{N}(0, 1)$.

Density function:

$$\varphi(x) = \frac{1}{\sqrt{2\pi}} e^{-x^2/2}$$

Then

$$\begin{aligned} \Pr[r = (x_1, \dots, x_n)] &= \frac{1}{(\sqrt{2\pi})^n} e^{-x_1^2/2} \cdot e^{-x_2^2/2} \cdot \dots \cdot e^{-x_n^2/2} dx_1 \cdot \dots \cdot dx_n \\ &= \frac{1}{(\sqrt{2\pi})^n} e^{-\frac{1}{2}(x_1^2 + \dots + x_n^2)} dx_1 \cdot \dots \cdot dx_n \end{aligned}$$

Hence the probability for a point only depends on its distance to the origin.

Rounding the SDP-Solution

Fact

The projection of r onto two unit vectors e_1 and e_2 are independent and are normally distributed with mean 0 and variance 1 iff e_1 and e_2 are orthogonal.

Note that this is clear if e_1 and e_2 are standard basis vectors.

Rounding the SDP-Solution

Corollary

If we project r onto a hyperplane its normalized projection $(r' / \|r'\|)$ is uniformly distributed on the unit circle within the hyperplane.

Rounding the SDP-Solution

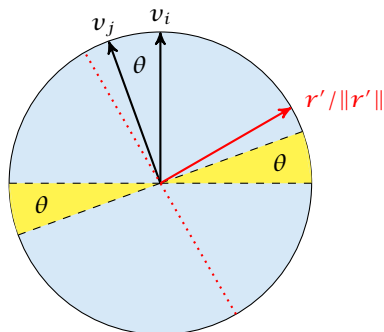

- ▶ if the normalized projection falls into the shaded region, v_i and v_j are rounded to different values
- ▶ this happens with probability θ/π

Rounding the SDP-Solution

- ▶ contribution of edge (i, j) to the SDP-relaxation:

$$\frac{1}{2}w_{ij}(1 - v_i^t v_j)$$

- ▶ (expected) contribution of edge (i, j) to the rounded instance $w_{ij} \arccos(v_i^t v_j) / \pi$
- ▶ ratio is at most

$$\min_{x \in [-1, 1]} \frac{2 \arccos(x)}{\pi(1 - x)} \geq 0.878$$

Rounding the SDP-Solution

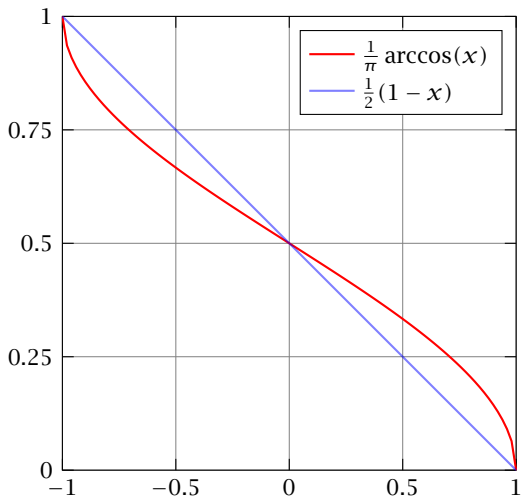

Rounding the SDP-Solution

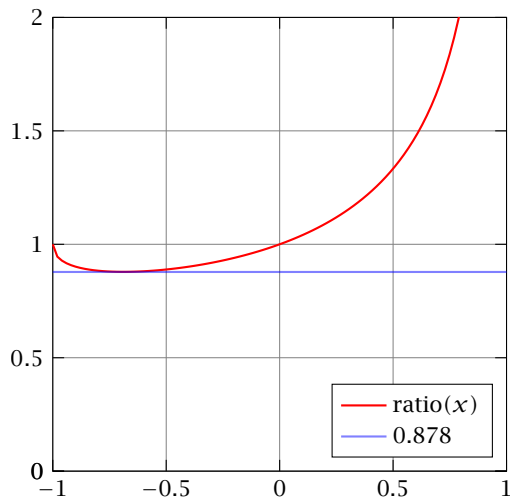

Rounding the SDP-Solution

Theorem 44

Given the unique games conjecture, there is no α -approximation for the maximum cut problem with constant

$$\alpha > \min_{x \in [-1,1]} \frac{2 \arccos(x)}{\pi(1-x)}$$

unless $P = NP$.

Repetition: Primal Dual for Set Cover

Primal Relaxation:

$$\begin{array}{ll} \min & \sum_{i=1}^k w_i x_i \\ \text{s.t.} & \forall u \in U \quad \sum_{i:u \in S_i} x_i \geq 1 \\ & \forall i \in \{1, \dots, k\} \quad x_i \geq 0 \end{array}$$

Dual Formulation:

$$\begin{array}{ll} \max & \sum_{u \in U} y_u \\ \text{s.t.} & \forall i \in \{1, \dots, k\} \quad \sum_{u:u \in S_i} y_u \leq w_i \\ & y_u \geq 0 \end{array}$$

Repetition: Primal Dual for Set Cover

Algorithm:

- ▶ Start with $y = 0$ (feasible dual solution).
Start with $x = 0$ (integral primal solution that may be infeasible).
- ▶ While x not feasible
 - ▶ Identify an element e that is not covered in current primal integral solution.
 - ▶ Increase dual variable y_e until a dual constraint becomes tight (maybe increase by 0!).
 - ▶ If this is the constraint for set S_j set $x_j = 1$ (add this set to your solution).

Repetition: Primal Dual for Set Cover

Analysis:

- ▶ For every set S_j with $x_j = 1$ we have

$$\sum_{e \in S_j} y_e = w_j$$

- ▶ Hence our cost is

$$\begin{aligned} \sum_j w_j x_j &= \sum_j \sum_{e \in S_j} y_e = \sum_e |\{j : e \in S_j\}| \cdot y_e \\ &\leq f \cdot \sum_e y_e \leq f \cdot \text{OPT} \end{aligned}$$

Note that the constructed pair of primal and dual solution fulfills **primal slackness conditions**.

This means

$$x_j > 0 \Rightarrow \sum_{e \in S_j} y_e = w_j$$

If we would also fulfill **dual slackness conditions**

$$y_e > 0 \Rightarrow \sum_{j: e \in S_j} x_j = 1$$

then the solution would be **optimal!!!!**

We don't fulfill these constraint but we fulfill an approximate version:

$$y_e > 0 \Rightarrow 1 \leq \sum_{j:e \in S_j} x_j \leq f$$

This is sufficient to show that the solution is an f -approximation.

Suppose we have a primal/dual pair

$$\begin{array}{ll} \min & \sum_j c_j x_j \\ \text{s.t.} & \forall i \quad \sum_j a_{ij} x_j \geq b_i \\ & \forall j \quad x_j \geq 0 \end{array}$$

$$\begin{array}{ll} \max & \sum_i b_i y_i \\ \text{s.t.} & \forall j \quad \sum_i a_{ij} y_i \leq c_j \\ & \forall i \quad y_i \geq 0 \end{array}$$

and solutions that fulfill approximate slackness conditions:

$$x_j > 0 \Rightarrow \sum_i a_{ij} y_i \geq \frac{1}{\alpha} c_j$$

$$y_i > 0 \Rightarrow \sum_j a_{ij} x_j \leq \beta b_i$$

Then

right hand side of j -th
dual constraint

$$\sum_j c_j x_j \leq \alpha \sum_j \left(\sum_i a_{ij} y_i \right) x_j$$

primal cost = $\alpha \sum_i \left(\sum_j a_{ij} x_j \right) y_i$

$$\leq \alpha \beta \cdot \sum_i b_i y_i$$

dual objective

Feedback Vertex Set for Undirected Graphs

- ▶ Given a graph $G = (V, E)$ and non-negative weights $w_v \geq 0$ for vertex $v \in V$.
- ▶ Choose a minimum cost subset of vertices s.t. every cycle contains at least one vertex.

We can encode this as an instance of Set Cover

- ▶ Each vertex can be viewed as a set that contains some cycles.
- ▶ However, this encoding gives a Set Cover instance of non-polynomial size.
- ▶ The $O(\log n)$ -approximation for Set Cover does not help us to get a good solution.

Let \mathcal{C} denote the set of all cycles (where a cycle is identified by its set of vertices)

Primal Relaxation:

$$\begin{array}{ll} \min & \sum_v w_v x_v \\ \text{s.t.} & \forall C \in \mathcal{C} \quad \sum_{v \in C} x_v \geq 1 \\ & \forall v \quad x_v \geq 0 \end{array}$$

Dual Formulation:

$$\begin{array}{ll} \max & \sum_{C \in \mathcal{C}} y_C \\ \text{s.t.} & \forall v \in V \quad \sum_{C: v \in C} y_C \leq w_v \\ & \forall C \quad y_C \geq 0 \end{array}$$

If we perform the previous dual technique for Set Cover we get the following:

- ▶ Start with $x = 0$ and $y = 0$
- ▶ While there is a cycle C that is not covered (does not contain a chosen vertex).
 - ▶ Increase y_C until dual constraint for some vertex v becomes tight.
 - ▶ set $x_v = 1$.

Then

$$\begin{aligned}\sum_v w_v x_v &= \sum_v \sum_{C:v \in C} y_C x_v \\ &= \sum_{v \in S} \sum_{C:v \in C} y_C \\ &= \sum_C |S \cap C| \cdot y_C\end{aligned}$$

where S is the set of vertices we choose.

If every cycle is short we get a good approximation ratio, but this is unrealistic.

Algorithm 1 FeedbackVertexSet

- 1: $y \leftarrow 0$
- 2: $x \leftarrow 0$
- 3: **while** exists cycle C in G **do**
- 4: increase y_C until there is $v \in C$ s.t. $\sum_{C:v \in C} y_C = w_v$
- 5: $x_v = 1$
- 6: remove v from G
- 7: repeatedly remove vertices of degree 1 from G

Idea:

Always choose a short cycle that is not covered. If we always find a cycle of length at most α we get an α -approximation.

Observation:

For any path P of vertices of degree 2 in G the algorithm chooses at most one vertex from P .

Observation:

If we always choose a cycle for which the number of vertices of degree at least 3 is at most α we get a 2α -approximation.

Theorem 45

In any graph with no vertices of degree 1, there always exists a cycle that has at most $\mathcal{O}(\log n)$ vertices of degree 3 or more. We can find such a cycle in linear time.

This means we have

$$y_C > 0 \Rightarrow |S \cap C| \leq \mathcal{O}(\log n) .$$

Primal Dual for Shortest Path

Given a graph $G = (V, E)$ with two nodes $s, t \in V$ and edge-weights $c : E \rightarrow \mathbb{R}^+$ find a shortest path between s and t w.r.t. edge-weights c .

$$\begin{array}{ll} \min & \sum_e c(e)x_e \\ \text{s.t.} & \forall S \in \mathcal{S} \quad \sum_{e:\delta(S)} x_e \geq 1 \\ & \forall e \in E \quad x_e \in \{0, 1\} \end{array}$$

Here $\delta(S)$ denotes the set of edges with exactly one end-point in S , and $\mathcal{S} = \{S \subseteq V : s \in S, t \notin S\}$.

Primal Dual for Shortest Path

The Dual:

$$\begin{array}{ll} \max & \sum_S y_S \\ \text{s.t.} & \forall e \in E \quad \sum_{S:e \in \delta(S)} y_S \leq c(e) \\ & \forall S \in \mathcal{S} \quad y_S \geq 0 \end{array}$$

Here $\delta(S)$ denotes the set of edges with exactly one end-point in S , and $\mathcal{S} = \{S \subseteq V : s \in S, t \notin S\}$.

Primal Dual for Shortest Path

We can interpret the value y_S as the width of a moat surrounding the set S .

Each set can have its own moat but all moats must be disjoint.

An edge cannot be shorter than all the moats that it has to cross.

Algorithm 1 PrimalDualShortestPath

- 1: $\gamma \leftarrow 0$
- 2: $F \leftarrow \emptyset$
- 3: **while** there is no s - t path in (V, F) **do**
- 4: Let C be the connected component of (V, F) containing s
- 5: Increase γ_C until there is an edge $e' \in \delta(C)$ such that $\sum_{S:e' \in \delta(S)} \gamma_S = c(e')$.
- 6: $F \leftarrow F \cup \{e'\}$
- 7: **Let P be an s - t path in (V, F)**
- 8: **return P**

Lemma 46

At each point in time the set F forms a tree.

Proof:

- ▶ In each iteration we take the current connected component from (V, F) that contains s (call this component C) and add some edge from $\delta(C)$ to F .
- ▶ Since, at most one end-point of the new edge is in C the edge cannot close a cycle.

$$\begin{aligned} \sum_{e \in P} c(e) &= \sum_{e \in P} \sum_{S: e \in \delta(S)} y_S \\ &= \sum_{S: s \in S, t \notin S} |P \cap \delta(S)| \cdot y_S . \end{aligned}$$

If we can show that $y_S > 0$ implies $|P \cap \delta(S)| = 1$ gives

$$\sum_{e \in P} c(e) = \sum_S y_S \leq \text{OPT}$$

by weak duality.

Hence, we find a shortest path.

If S contains two edges from P then there must exist a subpath P' of P that starts and ends with a vertex from S (and all interior vertices are not in S).

When we increased y_S , S was a connected component of the set of edges F' that we had chosen till this point.

$F' \cup P'$ contains a cycle. Hence, also the final set of edges contains a cycle.

This is a contradiction.

Steiner Forest Problem:

Given a graph $G = (V, E)$, together with source-target pairs s_i, t_i , $i = 1, \dots, k$, and a cost function $c : E \rightarrow \mathbb{R}^+$ on the edges. Find a subset $F \subseteq E$ of the edges such that for every $i \in \{1, \dots, k\}$ there is a path between s_i and t_i only using edges in F .

$$\begin{array}{ll} \min & \sum_e c(e)x_e \\ \text{s.t.} & \forall S \subseteq V : S \in S_i \text{ for some } i \quad \sum_{e \in \delta(S)} x_e \geq 1 \\ & \forall e \in E \quad x_e \in \{0, 1\} \end{array}$$

Here S_i contains all sets S such that $s_i \in S$ and $t_i \notin S$.

$$\begin{array}{ll}
 \max & \sum_{S: \exists i \text{ s.t. } S \in S_i} \gamma_S \\
 \text{s.t.} & \forall e \in E \quad \sum_{S: e \in \delta(S)} \gamma_S \leq c(e) \\
 & \gamma_S \geq 0
 \end{array}$$

The difference to the dual of the shortest path problem is that we have many more variables (sets for which we can generate a moat of non-zero width).

Algorithm 1 FirstTry

- 1: $\gamma \leftarrow 0$
- 2: $F \leftarrow \emptyset$
- 3: **while** not all s_i-t_i pairs connected in F **do**
- 4: Let C be some connected component of (V, F)
 such that $|C \cap \{s_i, t_i\}| = 1$ for some i .
- 5: Increase γ_C until there is an edge $e' \in \delta(C)$ s.t.
 $\sum_{S \in \mathcal{S}_i; e' \in \delta(S)} \gamma_S = c_{e'}$
- 6: $F \leftarrow F \cup \{e'\}$
- 7: **return** $\bigcup_i P_i$

$$\sum_{e \in F} c(e) = \sum_{e \in F} \sum_{S: e \in \delta(S)} y_S = \sum_S |\delta(S) \cap F| \cdot y_S .$$

If we show that $y_S > 0$ implies that $|\delta(S) \cap F| \leq \alpha$ we are in good shape.

However, this is not true:

- ▶ Take a complete graph on $k + 1$ vertices v_0, v_1, \dots, v_k .
- ▶ The i -th pair is $v_0 - v_i$.
- ▶ The first component C could be $\{v_0\}$.
- ▶ We only set $y_{\{v_0\}} = 1$. All other dual variables stay 0.
- ▶ The final set F contains all edges $\{v_0, v_i\}$, $i = 1, \dots, k$.
- ▶ $y_{\{v_0\}} > 0$ but $|\delta(\{v_0\}) \cap F| = k$.

Algorithm 1 SecondTry

```
1:  $\gamma \leftarrow 0; F \leftarrow \emptyset; \ell \leftarrow 0$ 
2: while not all  $s_i-t_i$  pairs connected in  $F$  do
3:    $\ell \leftarrow \ell + 1$ 
4:   Let  $\mathfrak{C}$  be set of all connected components  $C$  of  $(V, F)$ 
      such that  $|C \cap \{s_i, t_i\}| = 1$  for some  $i$ .
5:   Increase  $\gamma_C$  for all  $C \in \mathfrak{C}$  uniformly until for some edge
       $e_\ell \in \delta(C')$ ,  $C' \in \mathfrak{C}$  s.t.  $\sum_{S: e_\ell \in \delta(S)} \gamma_S = c_{e_\ell}$ 
6:    $F \leftarrow F \cup \{e_\ell\}$ 
7:  $F' \leftarrow F$ 
8: for  $k \leftarrow \ell$  downto 1 do // reverse deletion
9:   if  $F' - e_k$  is feasible solution then
10:    remove  $e_k$  from  $F'$ 
11: return  $F'$ 
```

The reverse deletion step is not strictly necessary this way. It would also be sufficient to simply delete all unnecessary edges in any order.

Example

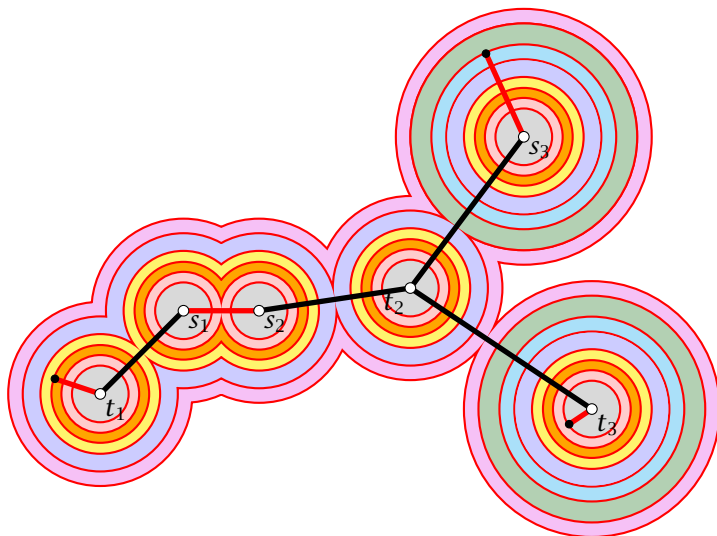

Lemma 47

For any \mathcal{C} in any iteration of the algorithm

$$\sum_{C \in \mathcal{C}} |\delta(C) \cap F'| \leq 2|\mathcal{C}|$$

This means that the number of times a moat from \mathcal{C} is crossed in the final solution is at most twice the number of moats.

Proof: later...

$$\sum_{e \in F'} c_e = \sum_{e \in F'} \sum_{S: e \in \delta(S)} y_S = \sum_S |F' \cap \delta(S)| \cdot y_S .$$

We want to show that

$$\sum_S |F' \cap \delta(S)| \cdot y_S \leq 2 \sum_S y_S$$

- ▶ In the i -th iteration the increase of the left-hand side is

$$\epsilon \sum_{C \in \mathcal{C}} |F' \cap \delta(C)|$$

and the increase of the right hand side is $2\epsilon|\mathcal{C}|$.

- ▶ Hence, by the previous lemma the inequality holds after the iteration if it holds in the beginning of the iteration.

Lemma 48

For any set of connected components \mathcal{C} in any iteration of the algorithm

$$\sum_{C \in \mathcal{C}} |\delta(C) \cap F'| \leq 2|\mathcal{C}|$$

Proof:

- ▶ At any point during the algorithm the set of edges forms a forest (why?).
- ▶ Fix iteration i . Let F_i be the set of edges in F at the beginning of the iteration.
- ▶ Let $H = F' - F_i$.
- ▶ All edges in H are necessary for the solution.

- ▶ Contract all edges in F_i into single vertices V' .
- ▶ We can consider the forest H on the set of vertices V' .
- ▶ Let $\deg(v)$ be the degree of a vertex $v \in V'$ within this forest.
- ▶ Color a vertex $v \in V'$ **red** if it corresponds to a component from \mathcal{C} (an active component). Otw. color it blue. (Let B the set of blue vertices (with non-zero degree) and R the set of red vertices)
- ▶ We have

$$\sum_{v \in R} \deg(v) \geq \sum_{C \in \mathcal{C}} |\delta(C) \cap V'| \stackrel{?}{\leq} 2|\mathcal{C}| = 2|R|$$

- ▶ Suppose that no node in B has degree one.
- ▶ Then

$$\begin{aligned}\sum_{v \in R} \deg(v) &= \sum_{v \in R \cup B} \deg(v) - \sum_{v \in B} \deg(v) \\ &\leq 2(|R| + |B|) - 2|B| = 2|R|\end{aligned}$$

- ▶ Every blue vertex with non-zero degree must have degree at least two.
 - ▶ Suppose not. The single edge connecting $b \in B$ comes from H , and, hence, is necessary.
 - ▶ But this means that the cluster corresponding to b must separate a source-target pair.
 - ▶ But then it must be a red node.

19 Cuts & Metrics

Shortest Path

$$\begin{array}{ll} \min & \sum_e c(e)x_e \\ \text{s.t.} & \forall S \in \mathcal{S} \quad \sum_{e \in \delta(S)} x_e \geq 1 \\ & \forall e \in E \quad x_e \in \{0,1\} \end{array}$$

\mathcal{S} is the set of subsets that separate s from t .

The Dual:

$$\begin{array}{ll} \max & \sum_S y_S \\ \text{s.t.} & \forall e \in E \quad \sum_{S:e \in \delta(S)} y_S \leq c(e) \\ & \forall S \in \mathcal{S} \quad y_S \geq 0 \end{array}$$

The **Separation Problem** for the Shortest Path LP is the Minimum Cut Problem.

19 Cuts & Metrics

Minimum Cut

$$\begin{array}{ll} \min & \sum_e c(e)x_e \\ \text{s.t.} & \forall P \in \mathcal{P} \quad \sum_{e \in P} x_e \geq 1 \\ & \forall e \in E \quad x_e \in \{0,1\} \end{array}$$

\mathcal{P} is the set of path that connect s and t .

The Dual:

$$\begin{array}{ll} \max & \sum_P y_P \\ \text{s.t.} & \forall e \in E \quad \sum_{P:e \in P} y_P \leq c(e) \\ & \forall P \in \mathcal{P} \quad y_P \geq 0 \end{array}$$

The **Separation Problem** for the Minimum Cut LP is the Shortest Path Problem.

19 Cuts & Metrics

Observations:

Suppose that ℓ_e -values are solution to Minimum Cut LP.

- ▶ We can view ℓ_e as defining the **length** of an edge.
- ▶ Define $d(u, v) = \min_{\text{path } P \text{ btw. } u \text{ and } v} \sum_{e \in P} \ell_e$ as the **Shortest Path Metric** induced by ℓ_e .
- ▶ We have $d(u, v) = \ell_e$ for every edge $e = (u, v)$, as otw. we could reduce ℓ_e without affecting the distance between s and t .

Remark for bean-counters:

d is not a metric on V but a semimetric as two nodes u and v could have distance zero.

How do we round the LP?

- ▶ Let $B(s, r)$ be the ball of radius r around s (w.r.t. metric d).
Formally:

$$B = \{v \in V \mid d(s, v) \leq r\}$$

- ▶ For $0 \leq r < 1$, $B(s, r)$ is an s - t -cut.

Which value of r should we choose? **choose randomly!!!**

Formally:

choose r **u.a.r.** (**uniformly at random**) from interval $[0, 1)$

What is the probability that an edge (u, v) is in the cut?

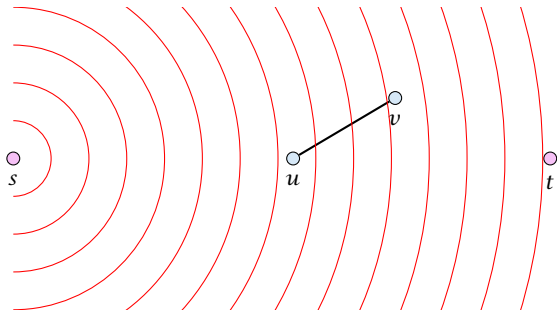

- ▶ assume wlog. $d(s, u) \leq d(s, v)$

$$\begin{aligned} \Pr[e \text{ is cut}] &= \Pr[r \in [d(s, u), d(s, v)]] \leq \frac{d(s, v) - d(s, u)}{1 - 0} \\ &\leq \ell_e \end{aligned}$$

What is the expected size of a cut?

$$\begin{aligned} E[\text{size of cut}] &= E\left[\sum_e c(e) \Pr[e \text{ is cut}]\right] \\ &\leq \sum_e c(e) \ell_e \end{aligned}$$

On the other hand:

$$\sum_e c(e) \ell_e \leq \text{size of mincut}$$

as the ℓ_e are the solution to the Mincut LP *relaxation*.

Hence, our rounding gives an optimal solution.

Minimum Multicut:

Given a graph $G = (V, E)$, together with source-target pairs s_i, t_i , $i = 1, \dots, k$, and a capacity function $c : E \rightarrow \mathbb{R}^+$ on the edges. Find a subset $F \subseteq E$ of the edges such that all s_i - t_i pairs lie in different components in $G = (V, E \setminus F)$.

$$\begin{array}{ll} \min & \sum_e c(e) \ell_e \\ \text{s.t.} & \forall P \in \mathcal{P}_i \text{ for some } i \quad \sum_{e \in P} \ell_e \geq 1 \\ & \forall e \in E \quad \ell_e \in \{0, 1\} \end{array}$$

Here \mathcal{P}_i contains all path P between s_i and t_i .

Re-using the analysis for the single-commodity case is difficult.

$$\Pr[e \text{ is cut}] \leq ?$$

- ▶ If for some R the balls $B(s_i, R)$ are disjoint between different sources, we get a $1/R$ approximation.
- ▶ However, this cannot be guaranteed.

- ▶ Assume for simplicity that all edge-length ℓ_e are multiples of $\delta \ll 1$.
- ▶ Replace the graph G by a graph G' , where an edge of length ℓ_e is replaced by ℓ_e/δ edges of length δ .
- ▶ Let $B(s_i, z)$ be the ball in G' that contains nodes v with distance $d(s_i, v) \leq z\delta$.

Algorithm 1 RegionGrowing(s_i, p)

```

1:  $z \leftarrow 0$ 
2: repeat
3:   flip a coin ( $\Pr[\text{heads}] = p$ )
4:    $z \leftarrow z + 1$ 
5: until heads
6: return  $B(s_i, z)$ 

```

Algorithm 1 Multicut(G')

```
1: while  $\exists s_i-t_i$  pair in  $G'$  do  
2:    $C \leftarrow \text{RegionGrowing}(s_i, p)$   
3:    $G' = G' \setminus C$  // cuts edges leaving  $C$   
4: return  $B(s_i, z)$ 
```

- ▶ probability of cutting an edge is only p
- ▶ a source either does not reach an edge during Region Growing; then it is not cut
- ▶ if it reaches the edge then it either **cuts** the edge or **protects** the edge from being cut by other sources
- ▶ if we choose $p = \delta$ the probability of cutting an edge is only its LP-value; our expected cost are at most **OPT**.

Problem:

We may not cut all source-target pairs.

A component that we remove may contain an s_i-t_i pair.

If we ensure that we cut before reaching radius $1/2$ we are in good shape.

- ▶ choose $p = 6 \ln k \cdot \delta$
- ▶ we make $\frac{1}{2\delta}$ trials before reaching radius $1/2$.
- ▶ we say a Region Growing is not successful if it does not terminate before reaching radius $1/2$.

$$\Pr[\text{not successful}] \leq (1-p)^{\frac{1}{2\delta}} = \left((1-p)^{1/p} \right)^{\frac{p}{2\delta}} \leq e^{-\frac{p}{2\delta}} \leq \frac{1}{k^3}$$

- ▶ Hence,

$$\Pr[\exists i \text{ that is not successful}] \leq \frac{1}{k^2}$$

What is expected cost?

$$\begin{aligned} E[\text{cutsize}] &= \Pr[\text{success}] \cdot E[\text{cutsize} \mid \text{success}] \\ &\quad + \Pr[\text{no success}] \cdot E[\text{cutsize} \mid \text{no success}] \end{aligned}$$

$$\begin{aligned} E[\text{cutsize} \mid \text{succ.}] &= \frac{E[\text{cutsize}] - \Pr[\text{no succ.}] \cdot E[\text{cutsize} \mid \text{no succ.}]}{\Pr[\text{success}]} \\ &\leq \frac{E[\text{cutsize}]}{\Pr[\text{success}]} \leq \frac{1}{1 - \frac{1}{k^2}} 6 \ln k \cdot \text{OPT} \leq 8 \ln k \cdot \text{OPT} \end{aligned}$$

Note: **success** means all source-target pairs separated

We assume $k \geq 2$.

If we are not successful we simply perform a trivial k -approximation.

This only increases the expected cost by at most $\frac{1}{k^2} \cdot kOPT \leq OPT/k$.

Hence, our final cost is $\mathcal{O}(\ln k) \cdot OPT$ in expectation.

Gap Introducing Reduction

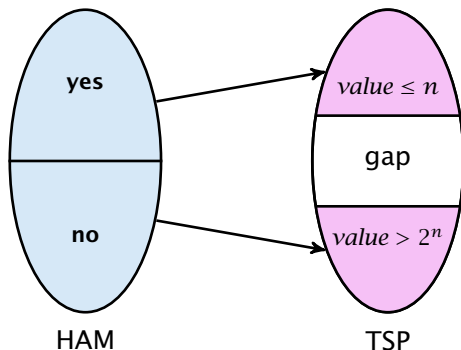

Reduction from Hamiltonian cycle to TSP

- ▶ instance that has Hamiltonian cycle is mapped to TSP instance with small cost
- ▶ otherwise it is mapped to instance with large cost
- ▶ \Rightarrow there is no $2^n/n$ -approximation for TSP

PCP theorem: Approximation View

Theorem 49 (PCP Theorem A)

There exists $\epsilon > 0$ for which there is gap introducing reduction between 3SAT and MAX3SAT.

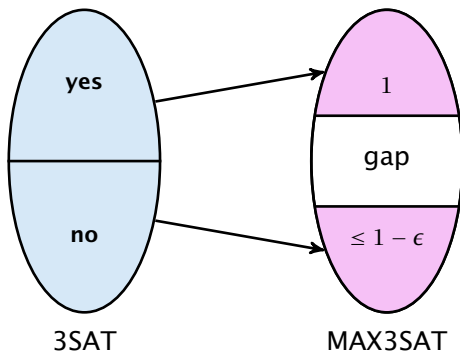

The standard formulation of the PCP theorem looks very different but the above theorem is equivalent. Originally, the PCP theorem is a result about interactive proof systems and its importance to hardness of approximation is somewhat a side effect.

Here the goal of the MAX3SAT-problem is to maximize the **fraction** of satisfied clauses. The above theorem implies that we cannot approximate MAX3SAT with a ratio better than $1 - \epsilon$.

PCP theorem: Proof System View

Definition 50 (NP)

A language $L \in \text{NP}$ if there exists a polynomial time, **deterministic** verifier V (a Turing machine), s.t.

$[x \in L]$ completeness

There exists a proof string y , $|y| = \text{poly}(|x|)$, s.t. $V(x, y) = \text{"accept"}$.

$[x \notin L]$ soundness

For any proof string y , $V(x, y) = \text{"reject"}$.

Note that requiring $|y| = \text{poly}(|x|)$ for $x \notin L$ does not make a difference (**why?**).

Definition 51 (NP)

A language $L \in \text{NP}$ if there exists a polynomial time, **deterministic** verifier V (a Turing machine), s.t.

$[x \in L]$ There exists a proof string y , $|y| = \text{poly}(|x|)$,
s.t. $V(x, y) = \text{“accept”}$.

$[x \notin L]$ For any proof string y , $V(x, y) = \text{“reject”}$.

Note that requiring $|y| = \text{poly}(|x|)$ for $x \notin L$ does not make a difference (**why?**).

Probabilistic Checkable Proofs

An **Oracle Turing Machine** M is a Turing machine that has access to an oracle.

Such an oracle allows M to solve some problem in a single step.

For example having access to a TSP-oracle π_{TSP} would allow M to write a TSP-instance x on a special oracle tape and obtain the answer (yes or no) in a single step.

For such TMs one looks in addition to running time also at **query complexity**, i.e., how often the machine queries the oracle.

For a proof string y , π_y is an oracle that upon given an index i returns the i -th character y_i of y .

Probabilistic Checkable Proofs

Non-adaptive means that e.g. the second proof-bit read by the verifier may not depend on the value of the first bit.

Definition 52 (PCP)

A language $L \in \text{PCP}_{c(n),s(n)}(r(n), q(n))$ if there exists a polynomial time, non-adaptive, **randomized** verifier V , s.t.

$[x \in L]$ There exists a proof string y , s.t. $V^{\pi y}(x) = \text{“accept”}$ with probability $\geq c(n)$.

$[x \notin L]$ For any proof string y , $V^{\pi y}(x) = \text{“accept”}$ with probability $\leq s(n)$.

The verifier uses at most $\mathcal{O}(r(n))$ random bits and makes at most $\mathcal{O}(q(n))$ oracle queries.

Note that the proof itself does not count towards the input of the verifier. The verifier has to write the number of a bit-position it wants to read onto a special tape, and then the corresponding bit from the proof is returned to the verifier. The proof may only be exponentially long, as a polynomial time verifier cannot address longer proofs.

Probabilistic Checkable Proofs

$c(n)$ is called the **completeness**. If not specified otw. $c(n) = 1$.
Probability of accepting a correct proof.

$s(n) < c(n)$ is called the **soundness**. If not specified otw.
 $s(n) = 1/2$. Probability of accepting a wrong proof.

$r(n)$ is called the **randomness complexity**, i.e., how many
random bits the (randomized) verifier uses.

$q(n)$ is the **query complexity** of the verifier.

Probabilistic Checkable Proofs

RP = coRP = P is a commonly believed conjecture. RP stands for randomized polynomial time (with a non-zero probability of rejecting a YES-instance).

- ▶ $P = \text{PCP}(0, 0)$
verifier without randomness and proof access is deterministic algorithm
- ▶ $\text{PCP}(\log n, 0) \subseteq P$
we can simulate $O(\log n)$ random bits in deterministic, polynomial time
- ▶ $\text{PCP}(0, \log n) \subseteq P$
we can simulate short proofs in polynomial time
- ▶ $\text{PCP}(\text{poly}(n), 0) = \text{coRP} \stackrel{?!}{=} P$
by definition; coRP is randomized polytime with one sided error (positive probability of accepting NO-instance)

Note that the first three statements also hold with equality

Probabilistic Checkable Proofs

- ▶ $\text{PCP}(0, \text{poly}(n)) = \text{NP}$
by definition; NP-verifier does not use randomness and asks polynomially many queries
- ▶ $\text{PCP}(\log n, \text{poly}(n)) \subseteq \text{NP}$
NP-verifier can simulate $\mathcal{O}(\log n)$ random bits
- ▶ $\text{PCP}(\text{poly}(n), 0) = \text{coRP} \stackrel{?!}{\subseteq} \text{NP}$
- ▶ $\text{NP} \subseteq \text{PCP}(\log n, 1)$
hard part of the PCP-theorem

PCP theorem: Proof System View

Theorem 53 (PCP Theorem B)

$$\text{NP} = \text{PCP}(\log n, 1)$$

Probabilistic Proof for Graph NonIsomorphism

GNI is the language of pairs of non-isomorphic graphs

Verifier gets input (G_0, G_1) (two graphs with n -nodes)

It expects a proof of the following form:

- ▶ For any **labeled** n -node graph H the H 's bit $P[H]$ of the proof fulfills

$$G_0 \equiv H \implies P[H] = 0$$

$$G_1 \equiv H \implies P[H] = 1$$

$$G_0, G_1 \not\equiv H \implies P[H] = \text{arbitrary}$$

Probabilistic Proof for Graph NonIsomorphism

Verifier:

- ▶ choose $b \in \{0, 1\}$ at random
- ▶ take graph G_b and apply a random permutation to obtain a labeled graph H
- ▶ check whether $P[H] = b$

If $G_0 \not\equiv G_1$ then by using the obvious proof the verifier will always accept.

If $G_0 \equiv G_1$ a proof only accepts with probability $1/2$.

- ▶ suppose $\pi(G_0) = G_1$
- ▶ if we accept for $b = 1$ and permutation π_{rand} we reject for $b = 0$ and permutation $\pi_{\text{rand}} \circ \pi$

Version B \Rightarrow Version A

- ▶ For 3SAT there exists a verifier that uses $c \log n$ random bits, reads $q = \mathcal{O}(1)$ bits from the proof, has completeness 1 and soundness $1/2$.
- ▶ fix x and r :

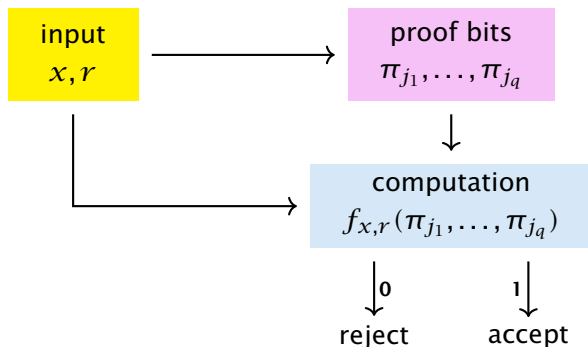

Version B \Rightarrow Version A

- ▶ transform Boolean formula $f_{x,r}$ into 3SAT formula $C_{x,r}$ (constant size, variables are proof bits)
- ▶ consider 3SAT formula $C_x := \bigwedge_r C_{x,r}$

[$x \in L$] There exists proof string y , s.t. all formulas $C_{x,r}$ evaluate to 1. Hence, all clauses in C_x satisfied.

[$x \notin L$] For any proof string y , at most 50% of formulas $C_{x,r}$ evaluate to 1. Since each contains only a constant number of clauses, a constant fraction of clauses in C_x are not satisfied.

- ▶ this means we have gap introducing reduction

Version A \Rightarrow Version B

We show: **Version A** \Rightarrow $\text{NP} \subseteq \text{PCP}_{1,1-\epsilon}(\log n, 1)$.

given $L \in \text{NP}$ we build a PCP-verifier for L

Verifier:

- ▶ 3SAT is NP-complete; map instance x for L into 3SAT instance I_x , s.t. I_x satisfiable iff $x \in L$
- ▶ map I_x to MAX3SAT instance C_x (**PCP Thm. Version A**)
- ▶ interpret proof as assignment to variables in C_x
- ▶ choose random clause X from C_x
- ▶ query variable assignment σ for X ;
- ▶ accept if $X(\sigma) = \text{true}$ otw. reject

Version A \Rightarrow Version B

- $[x \in L]$ There exists proof string y , s.t. all clauses in C_x evaluate to 1. In this case the verifier returns 1.
- $[x \notin L]$ For any proof string y , at most a $(1 - \epsilon)$ -fraction of clauses in C_x evaluate to 1. The verifier will reject with probability at least ϵ .

To show Theorem B we only need to run this verifier a constant number of times to push rejection probability above $1/2$.

$NP \subseteq PCP(\text{poly}(n), 1)$

Note that this approach has strong connections to error correction codes.

$PCP(\text{poly}(n), 1)$ means we have a potentially **exponentially** long proof but we only read a constant number of bits from it.

The idea is to encode an NP-witness (e.g. a satisfying assignment (say n bits)) by a code whose code-words have 2^n bits.

A wrong proof is either

- ▶ a code-word whose pre-image does not correspond to a satisfying assignment
- ▶ or, a sequence of bits that does not correspond to a code-word

We can detect both cases by querying a few positions.

The Code

$u \in \{0, 1\}^n$ (satisfying assignment)

Walsh-Hadamard Code:

$\text{WH}_u : \{0, 1\}^n \rightarrow \{0, 1\}, x \mapsto x^T u$ (over $\text{GF}(2)$)

The code-word for u is WH_u . We identify this function by a bit-vector of length 2^n .

The Code

Lemma 54

If $u \neq u'$ then WH_u and $WH_{u'}$ differ in at least 2^{n-1} bits.

Proof:

Suppose that $u - u' \neq 0$. Then

$$WH_u(x) \neq WH_{u'}(x) \iff (u - u')^T x \neq 0$$

This holds for 2^{n-1} different vectors x .

The Code

Suppose we are given access to a function $f : \{0, 1\}^n \rightarrow \{0, 1\}$ and want to check whether it is a codeword.

Since the set of codewords is the set of all linear functions $\{0, 1\}^n$ to $\{0, 1\}$ we can check

$$f(x + y) = f(x) + f(y)$$

for all 2^{2n} pairs x, y . **But that's not very efficient.**

$NP \subseteq PCP(\text{poly}(n), 1)$

Can we just check a constant number of positions?

NP \subseteq PCP(poly(n), 1)

Observe that for two codewords

$$\Pr_{x \in \{0,1\}^n} [f(x) = g(x)] = 1/2.$$

Definition 55

Let $\rho \in [0, 1]$. We say that $f, g : \{0, 1\}^n \rightarrow \{0, 1\}$ are ρ -close if

$$\Pr_{x \in \{0,1\}^n} [f(x) = g(x)] \geq \rho .$$

Theorem 56 (proof deferred)

Let $f : \{0, 1\}^n \rightarrow \{0, 1\}$ with

$$\Pr_{x, y \in \{0,1\}^n} [f(x) + f(y) = f(x + y)] \geq \rho > \frac{1}{2} .$$

Then there is a linear function \tilde{f} such that f and \tilde{f} are ρ -close.

$\text{NP} \subseteq \text{PCP}(\text{poly}(n), 1)$

We need $\mathcal{O}(1/\delta)$ trials to be sure that f is $(1 - \delta)$ -close to a linear function with (arbitrary) constant probability.

NP \subseteq PCP(poly(n), 1)

Suppose for $\delta < 1/4$ f is $(1 - \delta)$ -close to some linear function \tilde{f} .

\tilde{f} is uniquely defined by f , since linear functions differ on at least half their inputs.

Suppose we are given $x \in \{0, 1\}^n$ and access to f . Can we compute $\tilde{f}(x)$ using only constant number of queries?

NP \subseteq PCP(poly(n), 1)

Suppose we are given $x \in \{0, 1\}^n$ and access to f . Can we compute $\tilde{f}(x)$ using only constant number of queries?

1. Choose $x' \in \{0, 1\}^n$ u.a.r.
2. Set $x'' := x + x'$.
3. Let $y' = f(x')$ and $y'' = f(x'')$.
4. Output $y' + y''$.

x' and x'' are uniformly distributed (albeit dependent). With probability at least $1 - 2\delta$ we have $f(x') = \tilde{f}(x')$ and $f(x'') = \tilde{f}(x'')$.

Then the above routine returns $\tilde{f}(x)$.

This technique is known as local decoding of the Walsh-Hadamard code.

$NP \subseteq PCP(\text{poly}(n), 1)$

We show that $QUADEQ \in PCP(\text{poly}(n), 1)$. The theorem follows since any PCP -class is closed under polynomial time reductions.

QUADEQ

Given a system of quadratic equations over $GF(2)$. Is there a solution?

QUADEQ is NP-complete

- ▶ given 3SAT instance C represent it as Boolean circuit
e.g. $C = (x_1 \vee x_2 \vee x_3) \wedge (x_3 \vee x_4 \vee \bar{x}_5) \wedge (x_6 \vee x_7 \vee x_8)$
- ▶ add variable for every wire
- ▶ add constraint for every gate

OR: $i_1 + i_2 + i_1 \cdot i_2 = o$

AND: $i_1 \cdot i_2 = o$

NEG: $i = 1 - o$

- ▶ add constraint $out = 1$
- ▶ system is feasible iff
 C is satisfiable

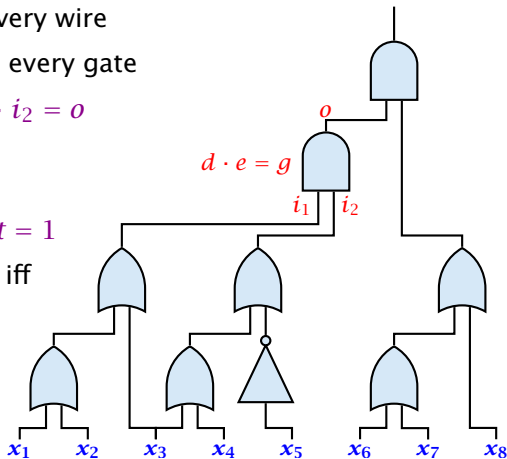

$\text{NP} \subseteq \text{PCP}(\text{poly}(n), 1)$

Note that over $\text{GF}(2)$ $x = x^2$. Therefore, we can assume that there are no terms of degree 1.

We encode an instance of **QUADEQ** by a matrix A that has n^2 columns; one for every pair i, j ; and a right hand side vector b .

For an n -dimensional vector x we use $x \otimes x$ to denote the n^2 -dimensional vector whose i, j -th entry is $x_i x_j$.

Then we are asked whether

$$A(x \otimes x) = b$$

has a solution.

$NP \subseteq PCP(\text{poly}(n), 1)$

Let A, b be an instance of **QUADEQ**. Let u be a satisfying assignment.

The correct PCP-proof will be the Walsh-Hadamard encodings of u and $u \otimes u$. **The verifier will accept such a proof with probability 1.**

We have to make sure that we reject proofs that do not correspond to codewords for vectors of the form u , and $u \otimes u$.

We also have to reject proofs that correspond to codewords for vectors of the form z , and $z \otimes z$, where z is not a satisfying assignment.

NP \subseteq PCP(poly(n), 1)

Recall that for a correct proof there is no difference between f and \tilde{f} .

Step 1. Linearity Test.

The proof contains $2^n + 2^{n^2}$ bits. This is interpreted as a pair of functions $f : \{0, 1\}^n \rightarrow \{0, 1\}$ and $g : \{0, 1\}^{n^2} \rightarrow \{0, 1\}$.

We do a 0.999-linearity test for both functions (requires a constant number of queries).

We also assume that for the remaining constant number of accesses WH-decoding succeeds and we recover $\tilde{f}(x)$.

Hence, our proof will only ever see \tilde{f} . To simplify notation we use f for \tilde{f} , in the following (similar for g, \tilde{g}).

$NP \subseteq PCP(\text{poly}(n), 1)$

We need to show that the probability of accepting a wrong proof is small.

This first step means that in order to fool us with reasonable probability a wrong proof needs to be very close to a linear function. The probability that we accept a proof when the functions are not close to linear is just a small constant.

Similarly, if the functions are close to linear then the probability that the Walsh Hadamard decoding fails (for *any* of the remaining accesses) is just a small constant. If we ignore this small constant error then a malicious prover could also provide a linear function (as a near linear function f is “rounded” by us to the corresponding linear function \tilde{f}). If this rounding is successful it doesn’t make sense for the prover to provide a function that is not linear.

NP \subseteq PCP(poly(n), 1)

Step 2. Verify that g encodes $u \otimes u$ where u is string encoded by f .

$f(r) = u^T r$ and $g(z) = w^T z$ since f, g are linear.

- ▶ choose r, r' independently, u.a.r. from $\{0, 1\}^n$
- ▶ if $f(r)f(r') \neq g(r \otimes r')$ reject
- ▶ repeat 3 times

NP \subseteq PCP(poly(n), 1)

A correct proof survives the test

$$\begin{aligned} f(r) \cdot f(r') &= u^T r \cdot u^T r' \\ &= \left(\sum_i u_i r_i \right) \cdot \left(\sum_j u_j r'_j \right) \\ &= \sum_{ij} u_i u_j r_i r'_j \\ &= (u \otimes u)^T (r \otimes r') \\ &= g(r \otimes r') \end{aligned}$$

NP \subseteq PCP(poly(n), 1)

Suppose that the proof is not correct and $w \neq u \otimes u$.

Let W be $n \times n$ -matrix with entries from w . Let U be matrix with $U_{ij} = u_i \cdot u_j$ (entries from $u \otimes u$).

$$g(r \otimes r') = w^T(r \otimes r') = \sum_{ij} w_{ij} r_i r'_j = r^T W r'$$

$$f(r)f(r') = u^T r \cdot u^T r' = r^T U r'$$

If $U \neq W$ then $W r' \neq U r'$ with probability at least 1/2. Then $r^T W r' \neq r^T U r'$ with probability at least 1/4.

For a non-zero vector x and a random vector r (both with elements from GF(2)), we have $\Pr[x^T r \neq 0] = \frac{1}{2}$. This holds because the product is zero iff the number of ones in r that “hit” ones in x in the product is even.

NP \subseteq PCP(poly(n), 1)

Step 3. Verify that f encodes satisfying assignment.

We need to check

$$A_k(u \otimes u) = b_k$$

where A_k is the k -th row of the constraint matrix. But the left hand side is just $g(A_k^T)$.

We can handle this by a single query but checking all constraints would take $\mathcal{O}(m)$ steps.

We compute $r^T A$, where $r \in_R \{0, 1\}^m$. If u is not a satisfying assignment then with probability 1/2 the vector r will hit an odd number of violated constraints.

In this case $r^T A(u \otimes u) \neq r^T b_k$. The left hand side is equal to $g(A^T r)$.

NP \subseteq PCP(poly(n), 1)

We used the following theorem for the linearity test:

Theorem 56

Let $f : \{0, 1\}^n \rightarrow \{0, 1\}$ with

$$\Pr_{x, y \in \{0, 1\}^n} [f(x) + f(y) = f(x + y)] \geq \rho > \frac{1}{2} .$$

Then there is a linear function \tilde{f} such that f and \tilde{f} are ρ -close.

NP \subseteq PCP(poly(n), 1)

Fourier Transform over GF(2)

In the following we use $\{-1, 1\}$ instead of $\{0, 1\}$. We map $b \in \{0, 1\}$ to $(-1)^b$.

This turns summation into multiplication.

The set of function $f : \{-1, 1\}^n \rightarrow \mathbb{R}$ form a 2^n -dimensional **Hilbert space**.

NP \subseteq PCP(poly(n), 1)

Hilbert space

- ▶ addition $(f + g)(x) = f(x) + g(x)$
- ▶ scalar multiplication $(\alpha f)(x) = \alpha f(x)$
- ▶ inner product $\langle f, g \rangle = E_{x \in \{-1, 1\}^n} [f(x)g(x)]$
(bilinear, $\langle f, f \rangle \geq 0$, and $\langle f, f \rangle = 0 \Rightarrow f = 0$)
- ▶ **completeness**: any sequence x_k of vectors for which

$$\sum_{k=1}^{\infty} \|x_k\| < \infty \text{ fulfills } \left\| L - \sum_{k=1}^N x_k \right\| \rightarrow 0$$

for some vector L .

$NP \subseteq PCP(\text{poly}(n), 1)$

standard basis

$$e_x(y) = \begin{cases} 1 & x = y \\ 0 & \text{otw.} \end{cases}$$

Then, $f(x) = \sum_i \alpha_i e_i(x)$ where $\alpha_x = f(x)$, this means the functions e_i form a basis. This basis is orthonormal.

NP \subseteq PCP(poly(n), 1)

fourier basis

For $\alpha \subseteq [n]$ define

$$\chi_\alpha(x) = \prod_{i \in \alpha} x_i$$

Note that

$$\langle \chi_\alpha, \chi_\beta \rangle = E_x[\chi_\alpha(x)\chi_\beta(x)] = E_x[\chi_{\alpha \Delta \beta}(x)] = \begin{cases} 1 & \alpha = \beta \\ 0 & \text{otw.} \end{cases}$$

This means the χ_α 's also define an orthonormal basis. (since we have 2^n orthonormal vectors...)

NP \subseteq PCP(poly(n), 1)

A function χ_α multiplies a set of x_i 's. Back in the GF(2)-world this means summing a set of z_i 's where $x_i = (-1)^{z_i}$.

This means the function χ_α correspond to linear functions in the GF(2) world.

NP \subseteq PCP(poly(n), 1)

We can write any function $f : \{-1, 1\}^n \rightarrow \mathbb{R}$ as

$$f = \sum_{\alpha} \hat{f}_{\alpha} \chi_{\alpha}$$

We call \hat{f}_{α} the α^{th} Fourier coefficient.

Lemma 57

1. $\langle f, g \rangle = \sum_{\alpha} \hat{f}_{\alpha} \hat{g}_{\alpha}$
2. $\langle f, f \rangle = \sum_{\alpha} \hat{f}_{\alpha}^2$

Note that for Boolean functions $f : \{-1, 1\}^n \rightarrow \{-1, 1\}$,
 $\langle f, f \rangle = 1$.

$$\langle f, f \rangle = E_x[f(x)^2] = 1$$

Linearity Test

in GF(2):

We want to show that if $\Pr_{x,y}[f(x) + f(y) = f(x + y)]$ is large than f has a large agreement with a linear function.

in Hilbert space: (we will prove)

Suppose $f : \{\pm 1\}^n \rightarrow \{-1, 1\}$ fulfills

$$\Pr_{x,y}[f(x)f(y) = f(x \circ y)] \geq \frac{1}{2} + \epsilon .$$

Then there is some $\alpha \subseteq [n]$, s.t. $\hat{f}_\alpha \geq 2\epsilon$.

Here $x \circ y$ denotes the n -dimensional vector with entry $x_i y_i$ in position i (**Hadamard product**).
Observe that we have $\chi_\alpha(x \circ y) = \chi_\alpha(x)\chi_\alpha(y)$.

Linearity Test

For Boolean functions $\langle f, g \rangle$ is the fraction of inputs on which f, g agree **minus** the fraction of inputs on which they disagree.

$$2\epsilon \leq \hat{f}_\alpha = \langle f, \chi_\alpha \rangle = \text{agree} - \text{disagree} = 2\text{agree} - 1$$

This gives that the agreement between f and χ_α is at least $\frac{1}{2} + \epsilon$.

Linearity Test

$$\Pr_{x,y}[f(x \circ y) = f(x)f(y)] \geq \frac{1}{2} + \epsilon$$

means that the fraction of inputs x, y on which $f(x \circ y)$ and $f(x)f(y)$ agree is at least $1/2 + \epsilon$.

This gives

$$\begin{aligned} E_{x,y}[f(x \circ y)f(x)f(y)] &= \text{agreement} - \text{disagreement} \\ &= 2\text{agreement} - 1 \\ &\geq 2\epsilon \end{aligned}$$

$$\begin{aligned}
2\epsilon &\leq E_{x,y} \left[f(x \circ y) f(x) f(y) \right] \\
&= E_{x,y} \left[\left(\sum_{\alpha} \hat{f}_{\alpha} \chi_{\alpha}(x \circ y) \right) \cdot \left(\sum_{\beta} \hat{f}_{\beta} \chi_{\beta}(x) \right) \cdot \left(\sum_{\gamma} \hat{f}_{\gamma} \chi_{\gamma}(y) \right) \right] \\
&= E_{x,y} \left[\sum_{\alpha,\beta,\gamma} \hat{f}_{\alpha} \hat{f}_{\beta} \hat{f}_{\gamma} \chi_{\alpha}(x) \chi_{\alpha}(y) \chi_{\beta}(x) \chi_{\gamma}(y) \right] \\
&= \sum_{\alpha,\beta,\gamma} \hat{f}_{\alpha} \hat{f}_{\beta} \hat{f}_{\gamma} \cdot E_x \left[\chi_{\alpha}(x) \chi_{\beta}(x) \right] E_y \left[\chi_{\alpha}(y) \chi_{\gamma}(y) \right] \\
&= \sum_{\alpha} \hat{f}_{\alpha}^3 \\
&\leq \max_{\alpha} \hat{f}_{\alpha} \cdot \sum_{\alpha} \hat{f}_{\alpha}^2 = \max_{\alpha} \hat{f}_{\alpha}
\end{aligned}$$

Approximation Preserving Reductions

AP-reduction

- ▶ $x \in I_1 \Rightarrow f(x, r) \in I_2$
- ▶ $\text{SOL}_1(x) \neq \emptyset \Rightarrow \text{SOL}_1(f(x, r)) \neq \emptyset$
- ▶ $y \in \text{SOL}_2(f(x, r)) \Rightarrow g(x, y, r) \in \text{SOL}_1(x)$
- ▶ f, g are polynomial time computable
- ▶ $R_2(f(x, r), y) \leq r \Rightarrow R_1(x, g(x, y, r)) \leq 1 + \alpha(r - 1)$

Label Cover

Input:

- ▶ bipartite graph $G = (V_1, V_2, E)$
- ▶ label sets L_1, L_2
- ▶ for every edge $(u, v) \in E$ a relation $R_{u,v} \subseteq L_1 \times L_2$ that describe assignments that make the edge **happy**.
- ▶ maximize number of happy edges

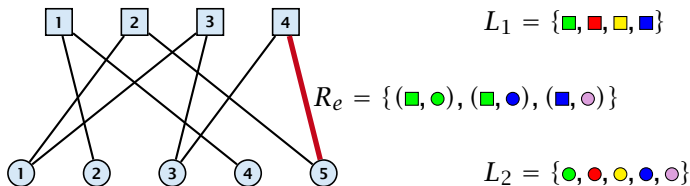

The label cover problem also has its origin in proof systems. It encodes a 2PR1 (2 prover 1 round system). Each side of the graph corresponds to a prover. An edge is a query consisting of a question for prover 1 and prover 2. If the answers are consistent the verifier accepts otherwise it rejects.

Label Cover

- ▶ an instance of label cover is (d_1, d_2) -regular if every vertex in L_1 has degree d_1 and every vertex in L_2 has degree d_2 .
- ▶ if every vertex has the same degree d the instance is called d -regular

Minimization version:

- ▶ assign a set $L_x \subseteq L_1$ of labels to every node $x \in L_1$ and a set $L_y \subseteq L_2$ to every node $y \in L_2$
- ▶ make sure that for every edge (x, y) there is $\ell_x \in L_x$ and $\ell_y \in L_y$ s.t. $(\ell_x, \ell_y) \in R_{x,y}$
- ▶ minimize $\sum_{x \in L_1} |L_x| + \sum_{y \in L_2} |L_y|$ (total labels used)

MAX E3SAT via Label Cover

instance:

$$\Phi(x) = (x_1 \vee \bar{x}_2 \vee x_3) \wedge (x_4 \vee x_2 \vee \bar{x}_3) \wedge (\bar{x}_1 \vee x_2 \vee \bar{x}_4)$$

corresponding graph:

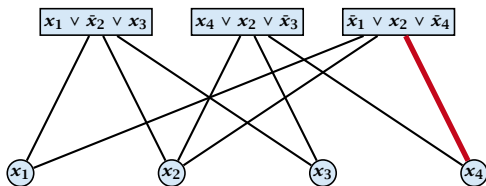

The verifier accepts if the labelling (assignment to variables in clauses at the top + assignment to variables at the bottom) causes the clause to evaluate to true and is consistent, i.e., the assignment of e.g. x_4 at the bottom is the same as the assignment given to x_4 in the labelling of the clause.

label sets: $L_1 = \{T, F\}^3, L_2 = \{T, F\}$ (T =true, F =false)

relation: $R_{C, x_i} = \{((u_i, u_j, u_k), u_i)\}$, where the clause C is over variables x_i, x_j, x_k and assignment (u_i, u_j, u_k) satisfies C

$$R = \{((F, F, F), F), ((F, T, F), F), ((F, F, T), T), ((F, T, T), T), ((T, T, T), T), ((T, T, F), F), ((T, F, F), F)\}$$

MAX E3SAT via Label Cover

Lemma 58

If we can satisfy k out of m clauses in ϕ we can make at least $3k + 2(m - k)$ edges happy.

Proof:

- ▶ for V_2 use the setting of the assignment that satisfies k clauses
- ▶ for satisfied clauses in V_1 use the corresponding assignment to the clause-variables (gives $3k$ happy edges)
- ▶ for unsatisfied clauses flip assignment of one of the variables; this makes one incident edge unhappy (gives $2(m - k)$ happy edges)

MAX E3SAT via Label Cover

Lemma 59

If we can satisfy at most k clauses in Φ we can make at most $3k + 2(m - k) = 2m + k$ edges happy.

Proof:

- ▶ the labeling of nodes in V_2 gives an assignment
- ▶ every unsatisfied clause in this assignment cannot be assigned a label that satisfies all 3 incident edges
- ▶ hence at most $3m - (m - k) = 2m + k$ edges are happy

Hardness for Label Cover

Here $\epsilon > 0$ is the constant from PCP Theorem A.

We cannot distinguish between the following two cases

- ▶ all $3m$ edges can be made happy
- ▶ at most $2m + (1 - \epsilon)m = (3 - \epsilon)m$ out of the $3m$ edges can be made happy

Hence, we cannot obtain an approximation constant $\alpha > \frac{3-\epsilon}{3}$.

(3, 5)-regular instances

Theorem 60

There is a constant ρ s.t. MAXE3SAT is hard to approximate with a factor of ρ even if restricted to instances where a variable appears in exactly 5 clauses.

Then our reduction has the following properties:

- ▶ the resulting Label Cover instance is (3, 5)-regular
- ▶ it is hard to approximate for a constant $\alpha < 1$
- ▶ given a label ℓ_1 for x there is at most one label ℓ_2 for y that makes edge (x, y) happy (**uniqueness property**)

(3, 5)-regular instances

The previous theorem can be obtained with a series of **gap-preserving reductions**:

- ▶ $\text{MAX3SAT} \leq \text{MAX3SAT}(\leq 29)$
- ▶ $\text{MAX3SAT}(\leq 29) \leq \text{MAX3SAT}(\leq 5)$
- ▶ $\text{MAX3SAT}(\leq 5) \leq \text{MAX3SAT}(= 5)$
- ▶ $\text{MAX3SAT}(= 5) \leq \text{MAXE3SAT}(= 5)$

Here $\text{MAX3SAT}(\leq 29)$ is the variant of MAX3SAT in which a variable appears in at most 29 clauses. Similar for the other problems.

Regular instances

We take the $(3, 5)$ -regular instance. We make 3 copies of every clause vertex and 5 copies of every variable vertex. Then we add edges between clause vertex and variable vertex iff the clause contains the variable. This increases the size by a constant factor. The gap instance can still either only satisfy a constant fraction of the edges or all edges. The uniqueness property still holds for the new instance.

Theorem 61

There is a constant $\alpha < 1$ such if there is an α -approximation algorithm for Label Cover on 15-regular instances then $P=NP$.

Given a label ℓ_1 for $x \in V_1$ there is at most one label ℓ_2 for y that makes (x, y) happy. (**uniqueness property**)

Parallel Repetition

We would like to increase the inapproximability for Label Cover.

In the verifier view, in order to decrease the acceptance probability of a wrong proof (or as here: a pair of wrong proofs) one could repeat the verification several times.

Unfortunately, we have a 2P1R-system, i.e., we are stuck with a single round and cannot simply repeat.

The idea is to use **parallel repetition**, i.e., we simply play several rounds in parallel and hope that the acceptance probability of wrong proofs goes down.

Parallel Repetition

Given Label Cover instance I with $G = (V_1, V_2, E)$, label sets L_1 and L_2 we construct a new instance I' :

- ▶ $V'_1 = V_1^k = V_1 \times \dots \times V_1$
- ▶ $V'_2 = V_2^k = V_2 \times \dots \times V_2$
- ▶ $L'_1 = L_1^k = L_1 \times \dots \times L_1$
- ▶ $L'_2 = L_2^k = L_2 \times \dots \times L_2$
- ▶ $E' = E^k = E \times \dots \times E$

An edge $((x_1, \dots, x_k), (y_1, \dots, y_k))$ whose end-points are labelled by $(\ell_1^x, \dots, \ell_k^x)$ and $(\ell_1^y, \dots, \ell_k^y)$ is happy if $(\ell_i^x, \ell_i^y) \in R_{x_i, y_i}$ for all i .

Parallel Repetition

If I is regular than also I' .

If I has the uniqueness property than also I' .

Did the gap increase?

- ▶ Suppose we have labelling ℓ_1, ℓ_2 that satisfies just an α -fraction of edges in I .
- ▶ We transfer this labelling to instance I' :
vertex (x_1, \dots, x_k) gets label $(\ell_1(x_1), \dots, \ell_1(x_k))$,
vertex (y_1, \dots, y_k) gets label $(\ell_2(y_1), \dots, \ell_2(y_k))$.
- ▶ **How many edges are happy?**
only $(\alpha|E|)^k$ out of $|E|^k$!!! (just an α^k fraction)

Does this always work?

Counter Example

Non interactive agreement:

- ▶ Two provers A and B
- ▶ The verifier generates two random bits b_A , and b_B , and sends one to A and one to B .
- ▶ Each prover has to answer one of A_0, A_1, B_0, B_1 with the meaning $A_0 :=$ prover A has been given a bit with value 0.
- ▶ The provers win if they give **the same answer** and if the **answer is correct**.

Counter Example

The provers can win with probability at most $1/2$.

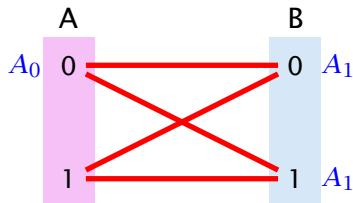

Regardless what we do 50% of edges are unhappy!

Counter Example

In the repeated game the provers can also win with probability $1/2$:

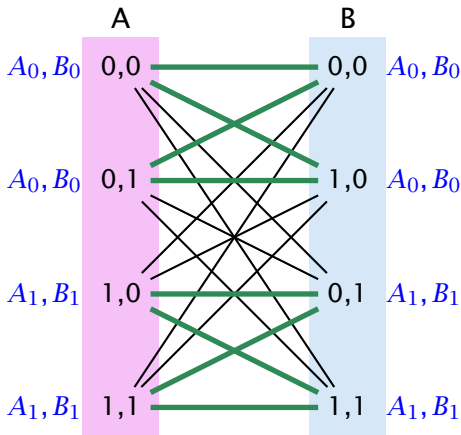

The provers give for the first game/coordinate an answer of the form "A has received..." (A_0 or A_1) and for the second an answer of the form "B has received..." (B_0 or B_1).

If the answer to be given is about himself a prover can answer correctly. If the answer to be given is about the other prover we return the same bit. This means e.g. Prover B answers A_1 for the first game iff in the second game he receives a 1-bit.

By this method the provers always win if Prover A gets the same bit in the first game as Prover B in the second game. This happens with probability $1/2$.

Note that this strategy is not possible for the provers if the game is repeated sequentially. How should prover B know (for her answer in the first game) which bit she is going to receive in the second game.

Theorem 62

There is a constant $c > 0$ such if $\text{OPT}(I) = |E|(1 - \delta)$ then $\text{OPT}(I') \leq |E'|(1 - \delta)^{\frac{ck}{\log L}}$, where $L = |L_1| + |L_2|$ denotes total number of labels in I .

proof is highly non-trivial

Hardness of Label Cover

Theorem 63

There are constants $c > 0$, $\delta < 1$ s.t. for any k we cannot distinguish regular instances for Label Cover in which either

- ▶ $\text{OPT}(I) = |E|$, or
- ▶ $\text{OPT}(I) = |E|(1 - \delta)^{ck}$

unless each problem in NP has an algorithm running in time $\mathcal{O}(n^{\mathcal{O}(k)})$.

Corollary 64

There is no α -approximation for Label Cover for *any* constant α .

Hardness of Set Cover

Theorem 65

There exist regular Label Cover instances s.t. we cannot distinguish whether

- ▶ *all edges are satisfiable, or*
- ▶ *at most a $1/\log^2(|L_1||E|)$ -fraction is satisfiable*

unless NP-problems have algorithms with running time $\mathcal{O}(n^{\mathcal{O}(\log \log n)})$.

choose $k \geq \frac{2}{c} \log_{1/(1-\delta)}(\log(|L_1||E|)) = \mathcal{O}(\log \log n)$.

Hardness of Set Cover

Partition System (s, t, h)

- ▶ universe U of size s
- ▶ t pairs of sets $(A_1, \bar{A}_1), \dots, (A_t, \bar{A}_t)$;
 $A_i \subseteq U, \bar{A}_i = U \setminus A_i$
- ▶ choosing from any h pairs only one of A_i, \bar{A}_i we do not cover the whole set U

we will show later:

for any h, t with $h \leq t$ there exist systems with $s = |U| \leq 4t^2 2^h$

Hardness of Set Cover

Given a Label Cover instance we construct a Set Cover instance;

The universe is $E \times U$, where U is the universe of some partition system; ($t = |L_1|$, $h = \log(|E||L_1|)$)

for all $u \in V_1, \ell_1 \in L_1$

$$S_{u, \ell_1} = \{((u, v), a) \mid (u, v) \in E, a \in A_{\ell_1}\}$$

for all $v \in V_2, \ell_2 \in L_2$

$$S_{v, \ell_2} = \{((u, v), a) \mid (u, v) \in E, a \in \bar{A}_{\ell_1}, \text{ where } (\ell_1, \ell_2) \in R_{(u, v)}\}$$

note that S_{v, ℓ_2} is well defined because of uniqueness property

Hardness of Set Cover

Suppose that we can make all edges happy.

Choose sets S_{u,ℓ_1} 's and S_{v,ℓ_2} 's, where ℓ_1 is the label we assigned to u , and ℓ_2 the label for v . ($|V_1|+|V_2|$ sets)

For an edge (u, v) , S_{v,ℓ_2} contains $\{(u, v)\} \times A_{\ell_2}$. For a happy edge S_{u,ℓ_1} contains $\{(u, v)\} \times \bar{A}_{\ell_2}$.

Since all edges are happy we have covered the whole universe.

If the Label Cover instance is completely satisfiable we can cover with $|V_1| + |V_2|$ sets.

Hardness of Set Cover

Lemma 66

Given a solution to the set cover instance using at most $\frac{h}{8}(|V_1| + |V_2|)$ sets we can find a solution to the Label Cover instance satisfying at least $\frac{2}{h^2}|E|$ edges.

If the Label Cover instance cannot satisfy a $2/h^2$ -fraction we cannot cover with $\frac{h}{8}(|V_1| + |V_2|)$ sets.

Since differentiating between both cases for the Label Cover instance is hard, we have an $\mathcal{O}(h)$ -hardness for Set Cover.

Hardness of Set Cover

- ▶ n_u : number of $S_{u,i}$'s in cover
- ▶ n_v : number of $S_{v,j}$'s in cover
- ▶ at most $1/4$ of the vertices can have $n_u, n_v \geq h/2$; mark these vertices
- ▶ at least half of the edges have both end-points unmarked, as the graph is regular
- ▶ for such an edge (u, v) we must have chosen $S_{u,i}$ and a corresponding $S_{v,j}$, s.t. $(i, j) \in R_{u,v}$ (making (u, v) happy)
- ▶ we choose a random label for u from the (at most $h/2$) chosen $S_{u,i}$ -sets and a random label for v from the (at most $h/2$) $S_{v,j}$ -sets
- ▶ (u, v) gets happy with probability at least $4/h^2$
- ▶ hence we make a $2/h^2$ -fraction of edges happy

Theorem 67

There is no $\frac{1}{32} \log n$ -approximation for the unweighted Set Cover problem unless problems in NP can be solved in time $\mathcal{O}(n^{\mathcal{O}(\log \log n)})$.

Given label cover instance (V_1, V_2, E) , label sets L_1 and L_2 ;

Set $h = \log(|E||L_1|)$ and $t = |L_1|$; Size of partition system is

$$s = |U| = 4t^2 2^h = 4|L_1|^2 (|E||L_1|)^2 = 4|E|^2 |L_1|^4$$

The size of the ground set is then

$$n = |E||U| = 4|E|^3 |L_1|^4 \leq (|E||L_2|)^4$$

for sufficiently large $|E|$. Then $h \geq \frac{1}{4} \log n$.

If we get an instance where all edges are satisfiable there **exists** a cover of size only $|V_1| + |V_2|$.

If we find a cover of size at most $\frac{h}{8} (|V_1| + |V_2|)$ we can use this to satisfy at least a fraction of $2/h^2 \geq 1/\log^2(|E||L_1|)$ of the edges. **this is not possible...**

Partition Systems

Lemma 68

Given h and t with $h \leq t$, there is a partition system of size $s = \ln(4t)h2^h \leq 4t^22^h$.

We pick t sets at random from the possible $2^{|U|}$ subsets of U .

Fix a choice of h of these sets, and a choice of h bits (whether we choose A_i or \bar{A}_i). There are $2^h \cdot \binom{t}{h}$ such choices.

What is the probability that a given choice covers U ?

The probability that an element $u \in A_i$ is $1/2$ (same for \bar{A}_i).

The probability that u is covered is $1 - \frac{1}{2^h}$.

The probability that all u are covered is $(1 - \frac{1}{2^h})^s$

The probability that there exists a choice such that all u are covered is at most

$$\binom{t}{h} 2^h \left(1 - \frac{1}{2^h}\right)^s \leq (2t)^h e^{-s/2^h} = (2t)^h \cdot e^{-h \ln(4t)} < \frac{1}{2} .$$

The random process outputs a partition system with constant probability!

Theorem 69

For any positive constant $\epsilon > 0$, it is the case that $\text{NP} \subseteq \text{PCP}_{1-\epsilon, 1/2+\epsilon}(\log n, 3)$. Moreover, the verifier just reads three bits from the proof, and bases its decision only on the parity of these bits.

It is NP-hard to approximate a MAXE3LIN problem by a factor better than $1/2 + \delta$, for any constant δ .

It is NP-hard to approximate MAX3SAT better than $7/8 + \delta$, for any constant δ .